

2.5V PRECISION SERIALVOLTAGE REFERENCE

- OUTPUT VOLTAGE : 2.5V \pm 1%
- INPUT VOLTAGE RANGE : 4.5V to 40V
- QUIESCENT CURRENT : 1.2mA typ.
- OUTPUT CURRENT : 10mA

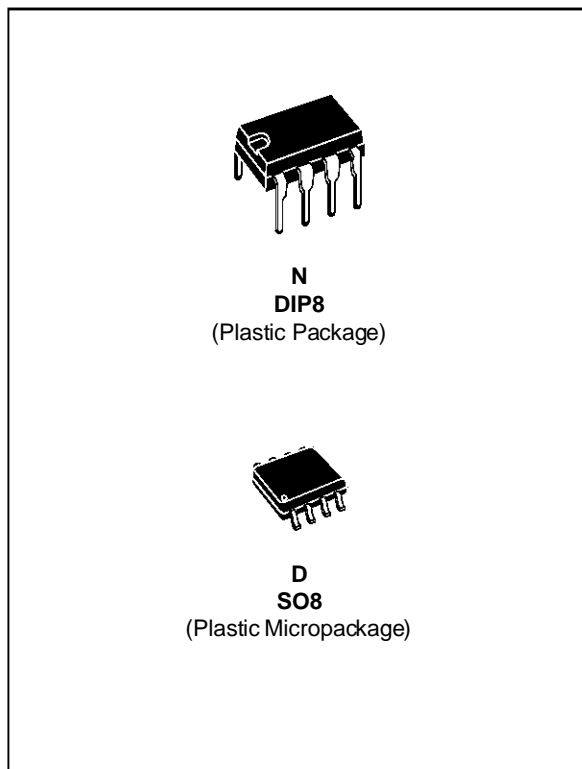

DESCRIPTION

The MC1403 is a serial 2.5V bandgap voltage reference. The major advantages are the 1% precision, the wide input voltage range (4.5V to 40V) and the low quiescent current (1.5mA max.)

ORDER CODES

Part number	Temperature Range	Package	
		N	D
MC1403	0°C, +70°C	•	•

PIN CONNECTIONS (top views)

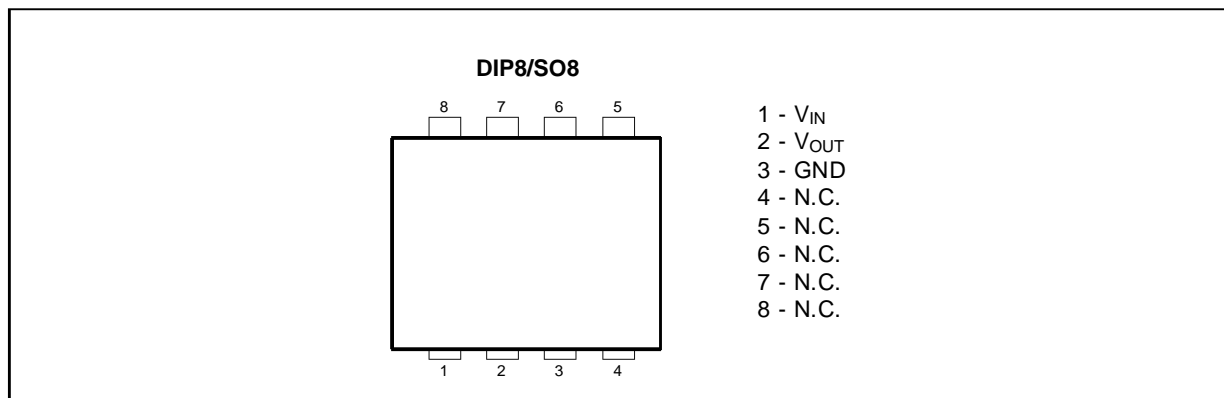

ABSOLUTE MAXIMUM RATINGS

Symbol	Parameter	Value	Unit
V _{IN}	Input Voltage	40	V
T _{oper}	Operating Free-air Temperature Range	0 to +70	°C
T _{stg}	Storage Temperature Range	-65 to +150	°C

OPERATING CONDITIONS

Symbol	Parameter	Value	Unit
V _{IN}	Input Voltage (I _o = 0mA)	4.5 to 40	V

ELECTRICAL CHARACTERISTICS

T_{amb} = 25°C, V_{IN} = 15V (unless otherwise specified)

Symbol	Parameter	Value			Unit
		Min.	Typ.	Max.	
V _{OUT}	Output Voltage I _{OUT} = 0mA	2.475	2.5	2.525	V
$\frac{\Delta V_O}{\Delta T}$	Temperature Coefficient of Output Voltage I _{OUT} = 0mA		10	40	ppm/°C
ΔV _O	Output Voltage change Over the Full Temperature Range I _{OUT} = 0mA		2	7	mV
Reg _{line}	Line Regulation I _{OUT} = 0mA, 4.5V ≤ V _i ≤ 15V I _{OUT} = 0mA, 15V ≤ V _i ≤ 40V			3 4.5	mV
Reg _{load}	Load Regulation 0 ≤ I _{OUT} ≤ 10mA			10	mV
I _Q	Quiescent Current I _{OUT} = 0mA		1.2	1.5	mA

PACKAGE MECHANICAL DATA
8 PINS - PLASTIC DIP

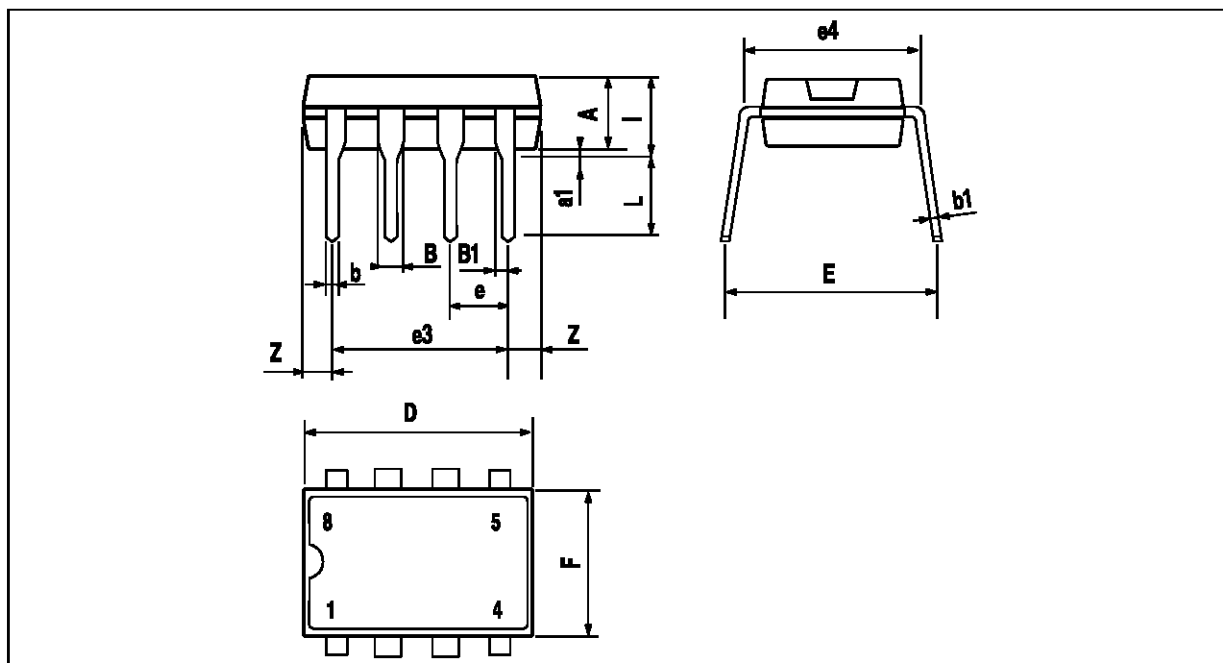

Dimensions	Millimeters			Inches		
	Min.	Typ.	Max.	Min.	Typ.	Max.
A		3.32			0.131	
a1	0.51			0.020		
B	1.15		1.65	0.045		0.065
b	0.356		0.55	0.014		0.022
b1	0.204		0.304	0.008		0.012
D			10.92			0.430
E	7.95		9.75	0.313		0.384
e		2.54			0.100	
e3		7.62			0.300	
e4		7.62			0.300	
F			6.6			0.260
i			5.08			0.200
L	3.18		3.81	0.125		0.150
Z			1.52			0.060

PACKAGE MECHANICAL DATA
 8 PINS - PLASTIC MICROPACKAGE (SO8)

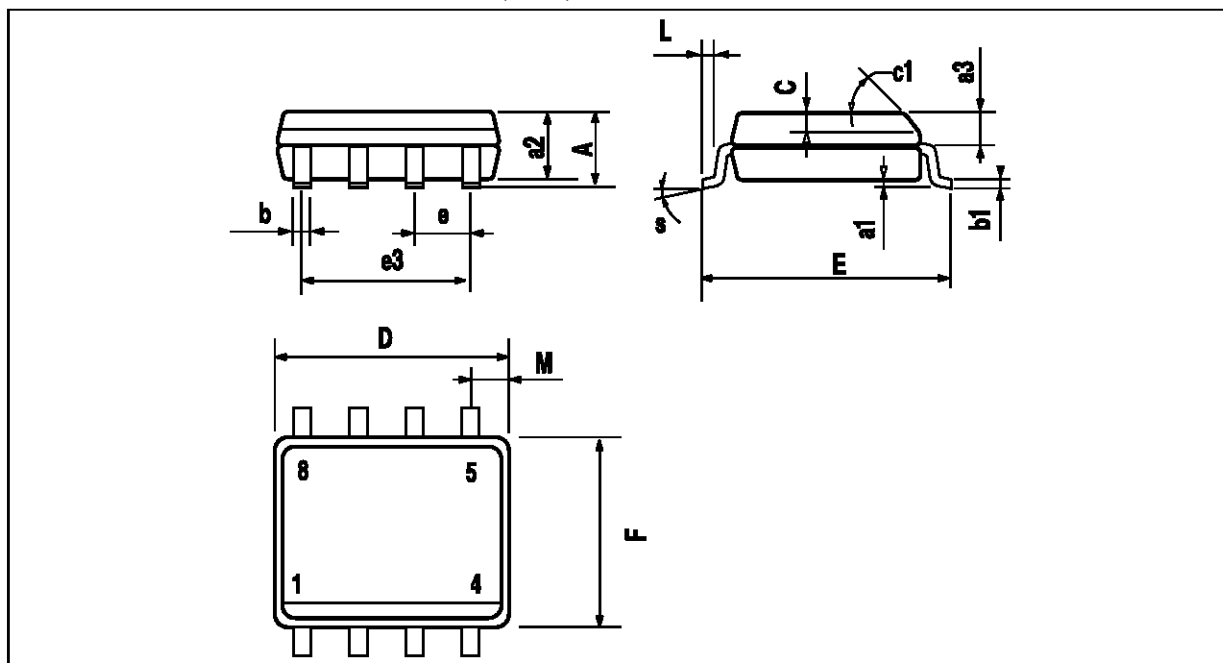

Dimensions	Millimeters			Inches		
	Min.	Typ.	Max.	Min.	Typ.	Max.
A			1.75			0.069
a1	0.1		0.25	0.004		0.010
a2			1.65			0.065
a3	0.65		0.85	0.026		0.033
b	0.35		0.48	0.014		0.019
b1	0.19		0.25	0.007		0.010
C	0.25		0.5	0.010		0.020
c1	45° (typ.)					
D	4.8		5.0	0.189		0.197
E	5.8		6.2	0.228		0.244
e		1.27			0.050	
e3		3.81			0.150	
F	3.8		4.0	0.150		0.157
L	0.4		1.27	0.016		0.050
M			0.6			0.024
S	8° (max.)					

Information furnished is believed to be accurate and reliable. However, SGS-THOMSON Microelectronics assumes no responsibility for the consequences of use of such information nor for any infringement of patents or other rights of third parties which may result from its use. No licence is granted by implication or otherwise under any patent or patent rights of SGS-THOMSON Microelectronics. Specifications mentioned in this publication are subject to change without notice. This publication supersedes and replaces all information previously supplied. SGS-THOMSON Microelectronics products are not authorized for use as critical components in life support devices or systems without express written approval of SGS-THOMSON Microelectronics.

© 1995 SGS-THOMSON Microelectronics - All Rights Reserved

SGS-THOMSON Microelectronics GROUP OF COMPANIES

Australia - Brazil - France - Germany - Hong Kong - Italy - Japan - Korea - Malaysia - Malta - Morocco - The Netherlands
 Singapore - Spain - Sweden - Switzerland - Taiwan - Thailand - United Kingdom - U.S.A.