

SANYO

No.4019

LA6525M

**Four-channel Bridge Driver
for Compact Disc Players**

OVERVIEW

The LA6525M is a four-channel, high-current bridge driver IC with output muting. It features two dual-output 400 mA (max) and two dual-output 700 mA (max) channels, making it ideal for use in compact disc players.

The LA6525M incorporates a reference voltage switch, a thermal protection circuit and two input buffer amplifiers in addition to the output driver amplifiers.

The LA6525M operates from a 5 V supply and is available in 30-pin MFPs.

FEATURES

- Four-channel bridge connection (BTL) power amplifier
- Output muting
- Two dual-output 400 mA (max) and two dual-output 700 mA (max) channels
- Reference voltage switch
- Thermal protection circuit
- Two input buffer amplifiers
- 5 V supply
- 30-pin MFP

PINOUT

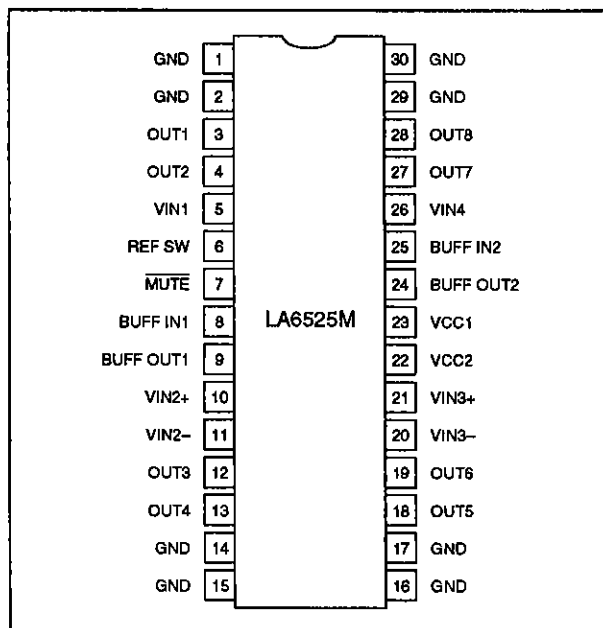

PACKAGE DIMENSIONS

Unit: mm

3073A-MFP30S

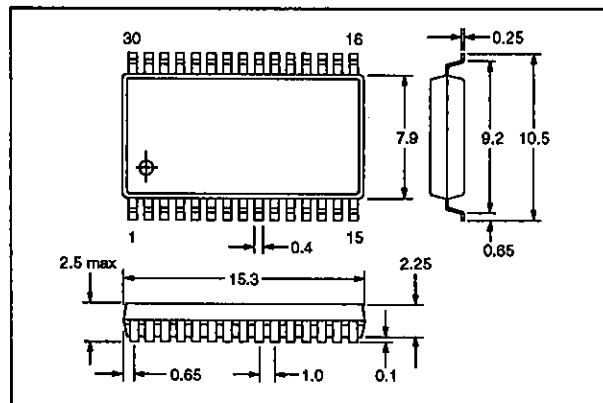

BLOCK DIAGRAM

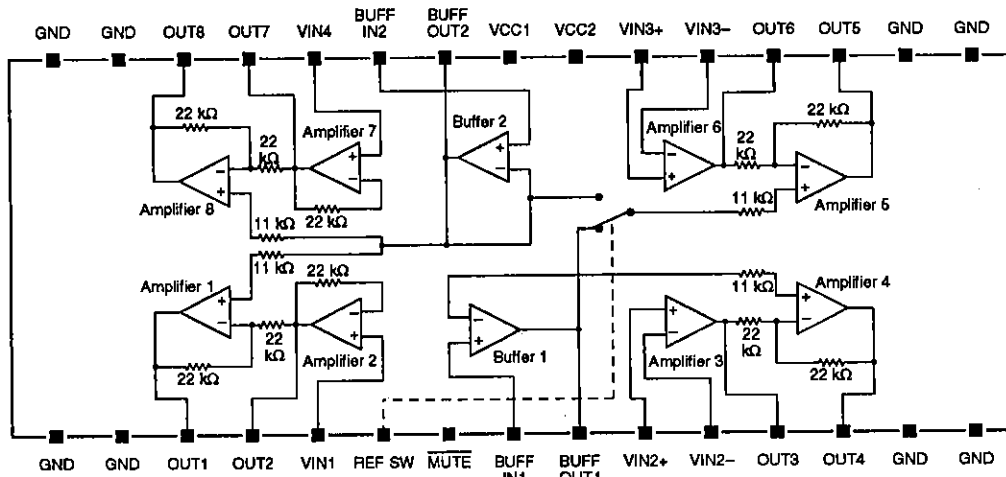

PIN DESCRIPTION

Number	Name	Description
1, 2, 14 to 17, 29, 30	GND	Ground
3	OUT1	Amplifier 1 output. 700 mA (max) output current
4	OUT2	Amplifier 2 output. 700 mA (max) output current
5	VIN1	Amplifier 2 input
6	REF SW	Reference switch control input
7	MUTE	Mute control input
8	BUFF IN1	Buffer 1 input
9	BUFF OUT1	Buffer 1 output
10	VIN2+	Amplifier 3 non-inverting input
11	VIN2-	Amplifier 3 inverting input
12	OUT3	Amplifier 3 output. 400 mA (max) output current
13	OUT4	Amplifier 4 output. 400 mA (max) output current
18	OUT5	Amplifier 5 output. 400 mA (max) output current
19	OUT6	Amplifier 6 output. 400 mA (max) output current
20	VIN3-	Amplifier 6 inverting input
21	VIN3+	Amplifier 6 non-inverting input
22, 23	VCC2, VCC1	5 V supplies
24	BUFF OUT2	Buffer 2 output
25	BUFF IN2	Buffer 2 input
26	VIN4	Amplifier 7 input
27	OUT7	Amplifier 7 output. 700 mA (max) output current
28	OUT8	Amplifier 8 output. 700 mA (max) output current

SPECIFICATIONS

Absolute Maximum Ratings

Parameter	Symbol	Rating	Unit
Supply voltage	V_{CC}	9	V
MUTE input voltage	V_{MUTE}	8	V
Differential input voltage	V_{ID}	8	V
Common-mode input voltage	V_{ICM}	8	V
Buffer amplifier input voltage	V_{IB}	8	V
Input voltage for all other inputs	V_I	8	V
Power dissipation	P_D	0.9	W
Operating temperature range	T_{opr}	-20 to 75	°C
Storage temperature range	T_{stg}	-55 to 150	°C

Recommended Operating Conditions

$T_a = 25\text{ °C}$

Parameter	Symbol	Rating	Unit
Supply voltage	V_{CC}	5	V

Electrical Characteristics

$V_{CC} = 5\text{ V}$, $T_a = 25\text{ °C}$

Parameter	Symbol	Condition	Rating			Unit
			min	typ	max	
Supply current	I_{CC}	Mute is OFF. See note 1.	25	40	60	mA
		Mute is ON. See note 1.	5	9	20	
BUFF IN1 and BUFF IN2 input voltage	V_{BICM}		1.5	-	$V_{CC} - 1.5$	V
Mute turn-ON voltage	V_{MUTE}		-	2.2	-	V
Reference switch turn-ON voltage	V_{REFSW}		-	2.5	-	V
Input voltage for all other inputs	V_{ICM}		1.0	-	$V_{CC} - 1.5$	V
Bridge amplifier closed-loop voltage gain	G_V		-	6	-	dB
OUT1, OUT2, OUT7 and OUT8 output source voltage	V_{O1}	See note 2.	3.4	3.6	-	V
OUT1, OUT2, OUT7 and OUT8 output sink voltage	V_{O2}	See note 2.	-	1.0	1.4	V
OUT3, OUT4, OUT5 and OUT6 output source voltage	V_{O3}	See note 2.	2.8	3.4	-	V
OUT3, OUT4, OUT5 and OUT6 output sink voltage	V_{O4}	See note 2.	-	1.6	2.2	V
Amplifiers 3 and 6 output limiting voltage	V_{OL}		-	5	-	V
OUT1, OUT2, OUT7 and OUT8 output offset voltage	V_{OFF1}	See note 3.	-50	-	50	mV

LA6525M

Parameter	Symbol	Condition	Rating			Unit
			min	typ	max	
OUT3 and OUT4 output offset voltage	V_{OFF2}	See note 3.	-30	-	30	mV
OUT5 and OUT6 output offset voltage	V_{OFFa}	Reference switch ON or OFF. See note 3.	-40	-	40	mV
Buffer 1 input-to-output voltage differential	V_{BI01}		-30	-	30	mV
Buffer 2 input-to-output voltage differential	V_{BI02}		0.5	0.6	0.8	V
Amplifier 2 input-to-output voltage differential	V_{IO2}		0.5	0.6	0.8	V
Amplifier 7 input-to-output voltage differential	V_{IO7}		0.5	0.6	0.8	V
VIN2+, VIN2-, VIN3+ and VIN3- input bias current	I_B	See note 4.	-	100	500	nA
Mute turn-ON current	I_{MUTE}		-	80	-	μ A
Reference switch turn-ON current	I_{REFSW}		-	26	-	μ A
OUT1 to OUT8 load resistance	R_L		-	8	-	Ω

Notes

1. Amplifier non-inverting inputs are held at 0.5 V and amplifier inverting inputs are connected to outputs through a 22 k Ω resistor.
2. Output-to-ground voltage when an 8 Ω load is connected between a pair of bridge amplifier outputs.
3. Voltage differential between a pair of bridge amplifier outputs
4. Amplifier non-inverting input is connected to 0.5V_{CC} through a 100 k Ω resistor, inverting input is connected to output through a 100 k Ω resistor. The current is determined from the voltage across the resistors.

Typical Performance Characteristics

Maximum power dissipation vs. ambient temperature

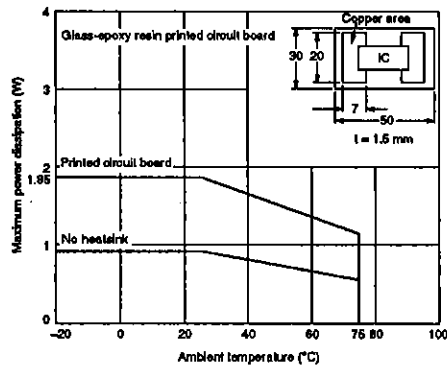

TYPICAL APPLICATION

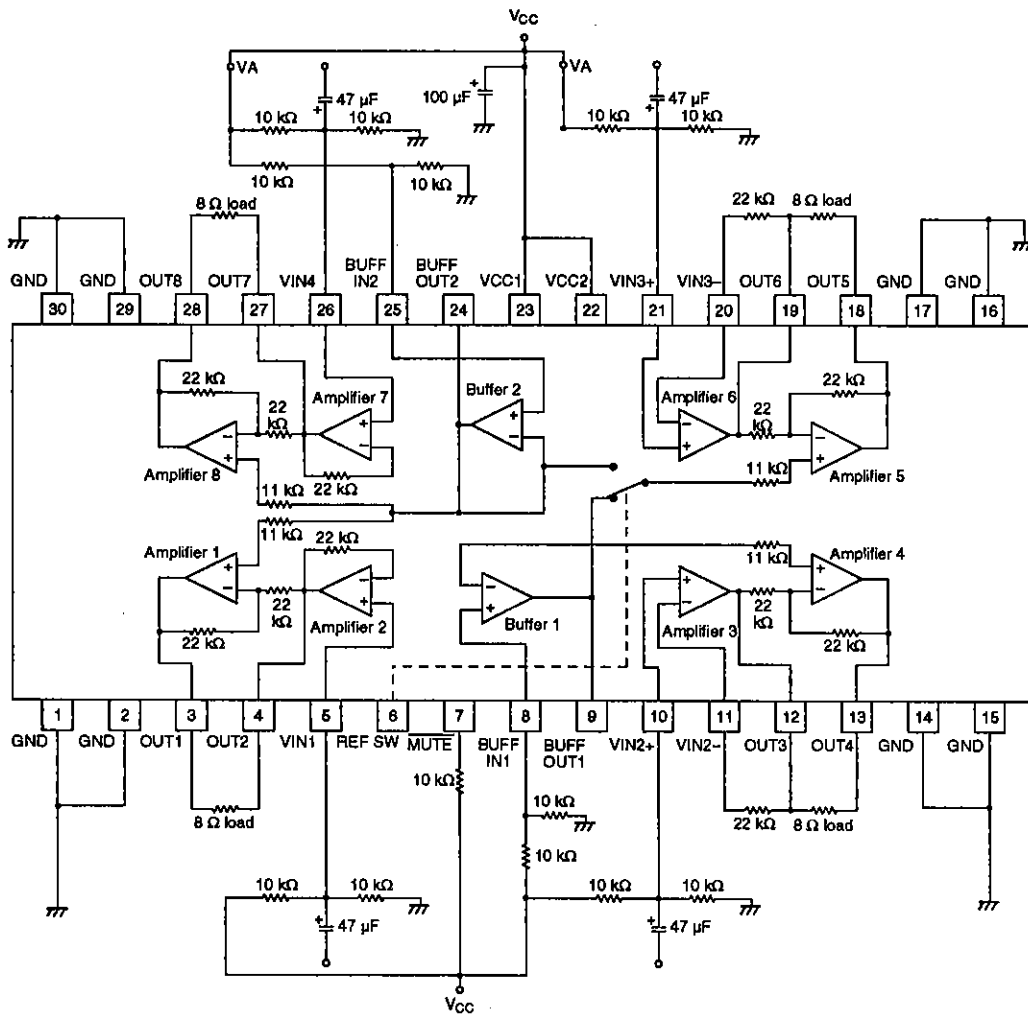

- No products described or contained herein are intended for use in surgical implants, life-support systems, aerospace equipment, nuclear power control systems, vehicles, disaster/crime-prevention equipment and the like, the failure of which may directly or indirectly cause injury, death or property loss.
- Anyone purchasing any products described or contained herein for an above-mentioned use shall:
 - ① Accept full responsibility and indemnify and defend SANYO ELECTRIC CO., LTD., its affiliates, subsidiaries and distributors and all their officers and employees, jointly and severally, against any and all claims and litigation and all damages, cost and expenses associated with such use;
 - ② Not impose any responsibility for any fault or negligence which may be cited in any such claim or litigation on SANYO ELECTRIC CO., LTD., its affiliates, subsidiaries and distributors or any of their officers and employees jointly or severally.
- Information (including circuit diagrams and circuit parameters) herein is for example only; it is not guaranteed for volume production. SANYO believes information herein is accurate and reliable, but no guarantees are made or implied regarding its use or any infringements of intellectual property rights or other rights of third parties.