

**SANYO**

No. 4036A

**LA4167M****1-channel Record/Playback System  
for Microcassette and Compact Cassette Recorders**

The LA4167M is a record/playback system IC supporting microcassette and compact cassette recorders. This is a high-performance IC that has on-chip a governor circuit for motor control, a voice sensor circuit that detects sounds and switches the motor on and off, and a cue-tone circuit for instantly finding the desired segment to play back.

**Functions**

- Microphone and playback preamps
- Record amplifier
- Power amplifier (BTL 4  $\Omega$  — single power during recording)
- Cue-tone oscillator and current amplifier (15 Hz typ. sine wave)
- Governor circuit
- Microphone power supply
- LED drive

**Features**

- Can switch between recording and playback with a single mechanical switch.
- Pause switch can switch the governor on and off.
- Cue-tone switch can record specified oscillator output (sine wave) during recording.
- The governor can automatically be switched on or off according to the mike input level during recording, and the on/off level for the governor can be varied continuously by the external volume control (used to adjust volume during playback).
- Mike monitor level is continuously variable.
- LED pin for turning off the LED only when cue-tone is on.

**Package Dimensions**

unit : mm

3073A - MFP30S

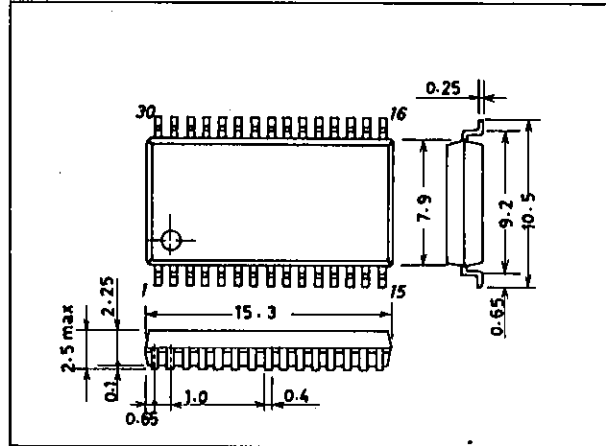
**SANYO Electric Co., Ltd. Semiconductor Business Headquarters**

TOKYO OFFICE Tokyo Bldg., 1-10, 1 Chome, Ueno, Taito-ku, TOKYO JAPAN

LA4167M

Maximum Ratings at Ta = 25°C

Maximum supply voltage	V <sub>CC</sub> max	4.5	unit
Allowable power dissipation	Pd max	800	mW
Operating temperature	Topr	-10 to +50	°C
Storage temperature	Tstg	-55 to +150	°C

Operating Conditions at Ta = 25°C

Recommended supply voltage	V <sub>CC</sub>	3.0	unit
Power supply voltage operating range	V <sub>CC</sub> op	1.8 to 3.6	V
Resistance load (power)	R <sub>L</sub> pwr	4	Ω
Resistance load (preamp)	R <sub>L</sub> pre	10	kΩ

Operating Characteristics at Ta = 25°C, V<sub>CC</sub> = 3.0 V, R<sub>L</sub> = 4Ω (power), R<sub>L</sub> = 10 kΩ (preamp), f = 1 kHz, 0 dBm = 0.775 V PLAY mode during BTL, REC mode during single

[Pre + Power + GVN]

Silence current	I <sub>CC-R</sub>	REC MODE, Vi=0V	min 6	typ 12	max 18	unit mA
	I <sub>CC-P</sub>	PLAY MODE, Vi=0V	12	18	25	mA

[Pre + Power]

Voltage gain	VG <sub>TP</sub>	PLAY MODE, V <sub>O</sub> =-5dBm	72	74.5	77	dB
--------------	------------------	----------------------------------	----	------	----	----

[EQ AMP]

Voltage gain (open)	VG <sub>OP</sub>	C <sub>NF</sub> =100μF	80	85	90	dB
Voltage gain (closed)	VG <sub>P</sub>		49.5	51.5	53.5	dB
Maximum output voltage	V <sub>OP</sub> max	THD=1%	0.5	0.75	1.0	V
Total harmonic distortion	THD <sub>P</sub>	V <sub>O</sub> =0.3V	0.01	0.2	0.6	%
Input conversion noise voltage	V <sub>NIP</sub>	Rg=2.2kΩ, DIN AUDIO		1.0	2.0	μV
Ripple rejection	Rrp	Rg=2.2kΩ, f <sub>R</sub> =1kHz, 1kHz Filter	45	60		dB

[MIC AMP]

Voltage gain (open)	VG <sub>OM</sub>	C <sub>NF</sub> =100μF	75	80	85	dB
Voltage gain (closed)	VG <sub>MI</sub>	EQ parameter ON, 3k, 3300pF IN	44	46	48	dB
Maximum output voltage	V <sub>OMAXM</sub>	THD=1%, R <sub>L</sub> =10kΩ	0.5	0.75	1.0	V
Total harmonic distortion	THD <sub>M</sub>	V <sub>O</sub> =0.3V	0.01	0.6	1.0	%
Input conversion noise voltage	V <sub>NIM</sub>	Rg=2.2kΩ, DIN AUDIO		1.0	2.0	μV
Ripple rejection	R <sub>rM</sub>	Rg=2.2kΩ, f <sub>R</sub> =1kHz, 1kHz Filter	45	65		dB
Input resistance	R <sub>iM</sub>		24	32	40	kΩ

[MIC + REC]

Voltage gain (closed)	VG <sub>RT</sub>	Vol min	64.5	66.5	68.5	dB
Maximum output voltage	V <sub>OMAXR</sub>	THD=5%	0.6	1.0	1.3	V
Total harmonic distortion	THD <sub>RT</sub>	V <sub>O</sub> =0.85V	0.5	1.2	2.0	%
Output noise voltage	V <sub>NORT</sub>	MIC input, Rg=2.2kΩ, DIN AUDIO		5.0	10	mV
Ripple rejection	R <sub>rRT</sub>		38	45		dB

[POWER AMP]

Voltage gain (open)	VG <sub>BTL</sub>	BTL ON, V <sub>O</sub> =-10dBm	21.5	24	26.5	dB
Voltage gain (closed)	VG <sub>SIN</sub>	BTL OFF, V <sub>O</sub> =-10dBm	20.5	23	25.5	dB
Output power (BTL)	P <sub>OBTL</sub>	THD=10% BTL	200	350	500	mW
Output power (SIN)	P <sub>OSIN</sub>	THD=10% Single	50	120	250	mW
Total harmonic distortion	THD <sub>BTL</sub>	BTL ON, V <sub>O</sub> =0.25V	0.1	0.8	2	%
Output noise voltage	V <sub>NOBTL</sub>	BTL ON, Rg=0	10	20	50	μV
Ripple rejection	R <sub>rBTL</sub>	BTL ON, Rg=0, f <sub>R</sub> =1kHz, 1kHz Filter	50	70		dB
Output DC offset	V <sub>DC OFF</sub>		0	10	50	mV
Input resistance	R <sub>iNBTL</sub>		21	30	39	kΩ

[ALC]

ALC width	ALC W	Input level width when output distortion is 5% and ALC is on	40	50	65	dB
ALC distortion	ALC THD	V <sub>im</sub> =-40dBm	0.1	1.5	2.5	%
ALC output	ALC V <sub>O</sub>	V <sub>im</sub> =-40dBm	0.35	0.45	0.55	V
ALC input on	ALC V <sub>IN</sub>		-75	-70	-65	dB

[Voice sensor (VOX)]

Operation start input voltage	V <sub>OP</sub> min	VOLUME (10kΩ) max	-93	-90	-87	dB
Input hysteresis	V <sub>OHL</sub>		3	6	9	dB

[Oscillator]

Oscillation frequency	f <sub>OSC</sub>	C <sub>OSC</sub> =0.47μF	13.5	15	16.5	Hz
-----------------------	------------------	--------------------------	------	----	------	----

[LED]

LED drive current	I <sub>LED</sub>	REC LED			15	mA
-------------------	------------------	---------	--	--	----	----

[Governor]

Reference voltage	Vref	I <sub>m</sub> =100mA	1.1	1.25	1.4	V
Shunt ratio	K	I <sub>m</sub> =50-100mA	45	50	55	
Residual voltage	Vsat	V <sub>REF</sub> =V <sub>CONT</sub> , I <sub>m</sub> =200mA	0.1	0.2	0.5	V

Continued on the following page.

Continued from the preceding page.

			min	typ	max	unit
Reference voltage — voltage characteristics	$\frac{\Delta V_{ref}}{V_{ref}} / \Delta V_{CC}$	$V_{CC}=1.8 \text{ to } 4.5V, I_m=100mA$	0	0.2	0.6	%/V
Shunt voltage ratio — voltage characteristics	$\frac{\Delta K}{K} / \Delta V_{CC}$	$V_{CC}=2.0 \text{ to } 4.5V, I_m=50-100mA$	0	0.3	0.7	%/V
Reference voltage — current characteristics	$\frac{\Delta V_{ref}}{V_{ref}} / \Delta I_m$	$I_m=50-200mA$	0	0.002	0.03	%/mA
Shunt voltage ratio — current characteristics	$\frac{\Delta K}{K} / \Delta I_m$	$I_m=50-100mA \text{ to } 150-200mA$	-0.07	0.03	0.07	%/mA

**Pin Array and Block Diagram**

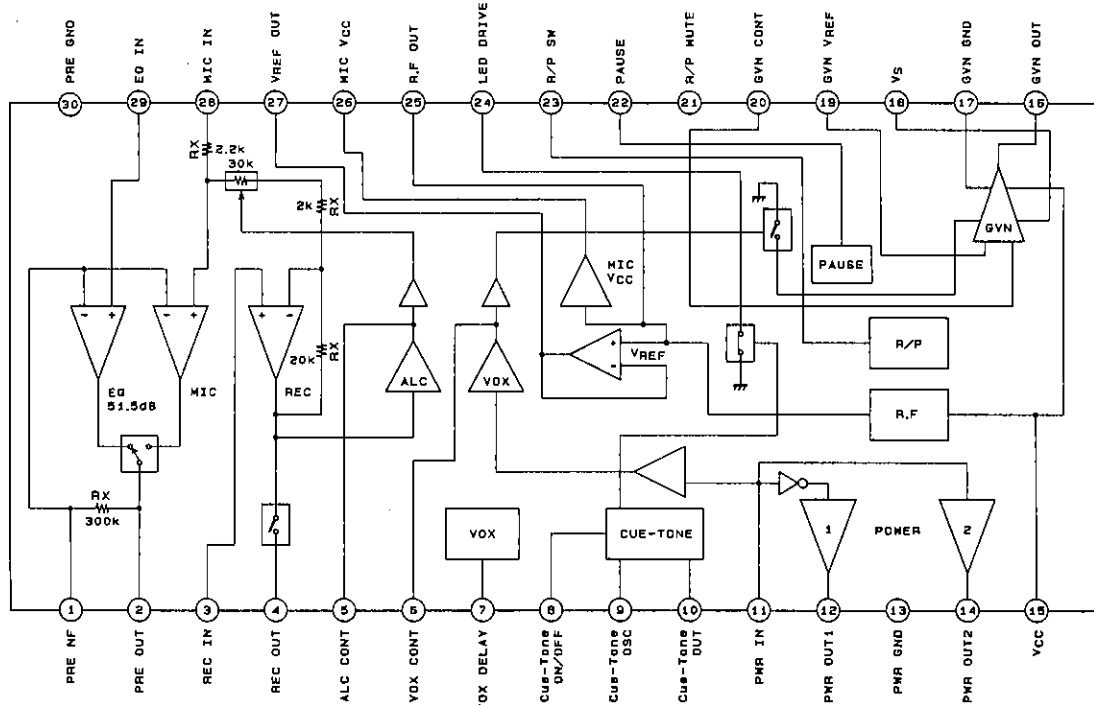

Unit (resistance:  $\Omega$ )

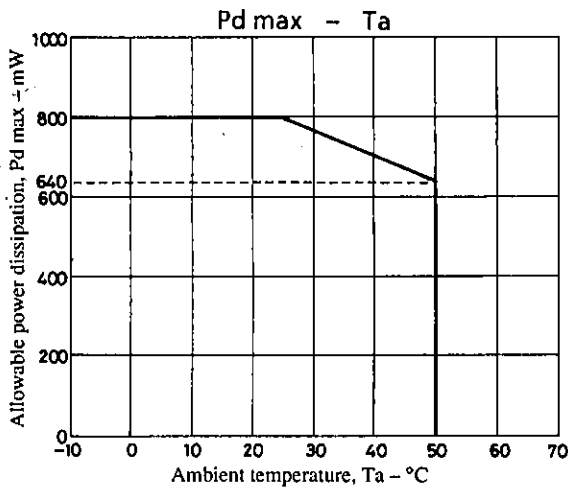

LA4167M

Test Circuit

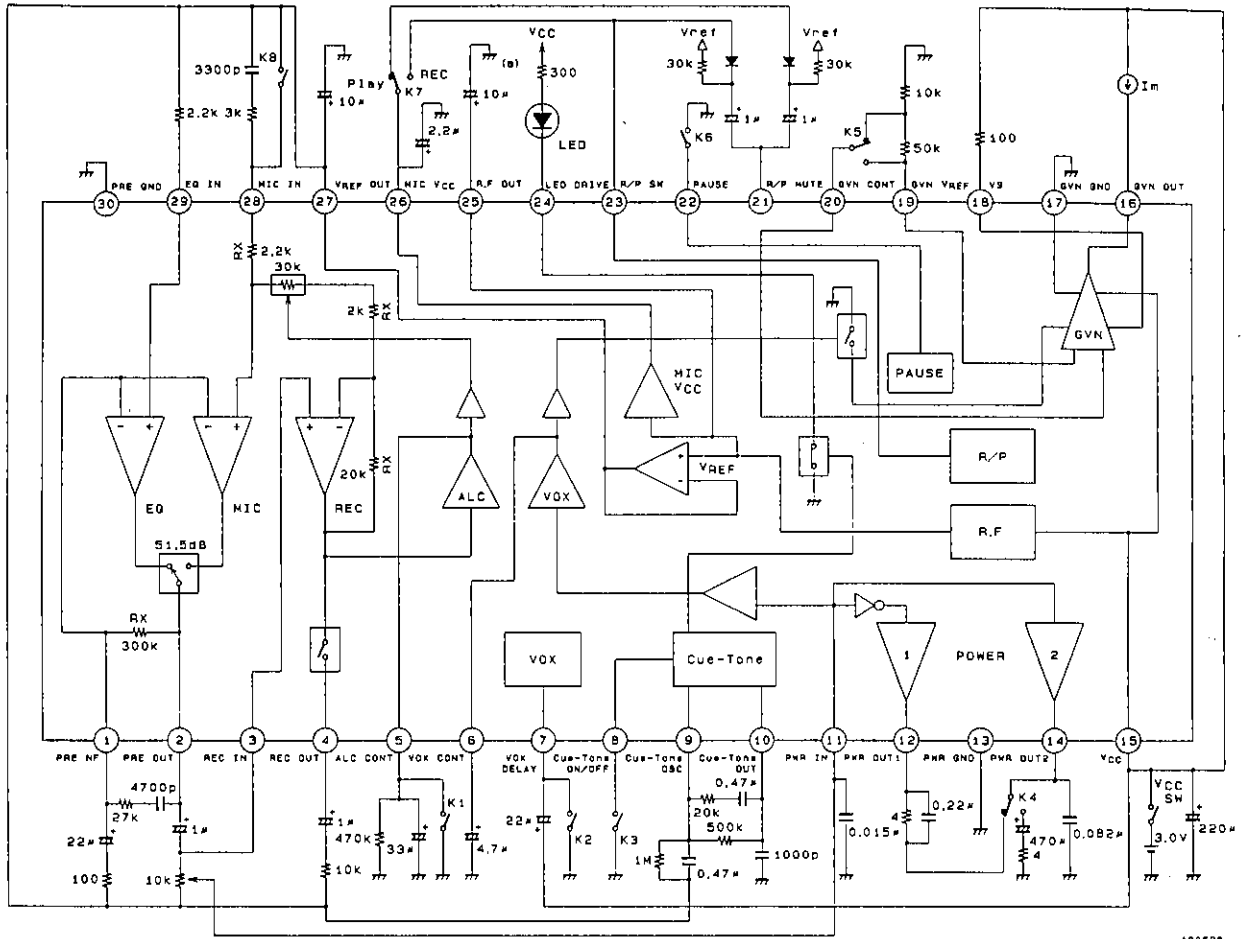

Sample Application Circuit

Unit (resistance:  $\Omega$ , capacitance: F)

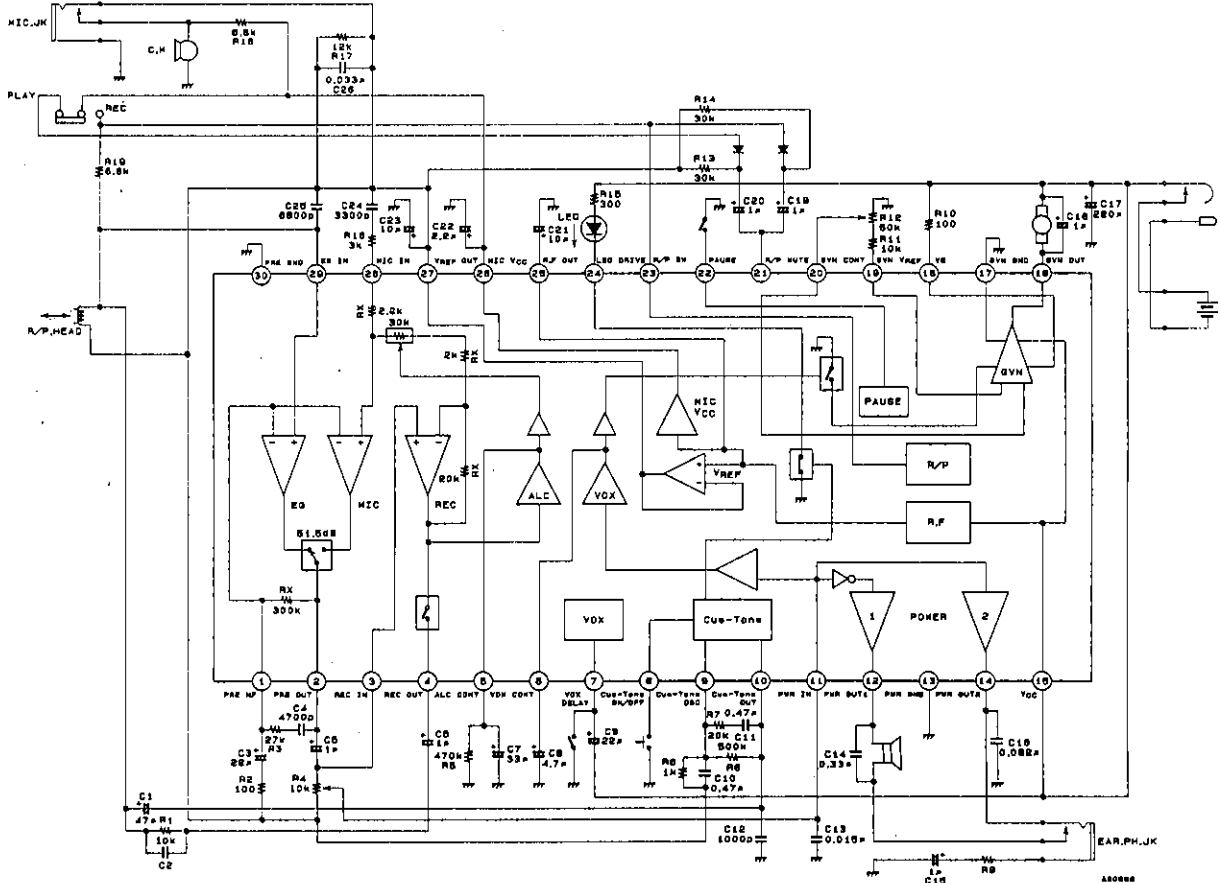

Pin Assignments and Equivalent Circuits

[V<sub>CC</sub>=3.0V]

Pin No.	Pin name	V <sub>DC</sub> (V)	Equivalent circuit	Remarks
1	PRE NF	1.5		NF pin common to preamp and MIC amp
2	PRE OUT	1.5		Output pin common to preamp and MIC amp
3	REC IN	1.5		Input for MIC output signal during REC mode
4	REC OUT	1.5		Pin 23 connected to MIC V <sub>CC</sub> for recording
5	ALC CONT	0.3to1.1		ALC operation over 0.65 V
6	VOX CONT	0.3to2.3		VOX turned on when MIC IN = -90 dB or higher

Unit (resistance: Ω, capacitance: F)

Continued on the following page.

Continued from the preceding page.

Pin No.	Pin name	V <sub>DC</sub> (V)	Equivalent circuit	Remarks
7	VOX DELAY			Turns off VOX at pin 7 GND
8	Cue-Tone ON/OFF			Turns on cue-tone at pin 8 GND
9	Cue-Tone OSC	1.5		<ul style="list-style-type: none"> <li>• Sets cue-tone frequency</li> <li>• <math>f_{OSC} = 15</math> Hz at pins 9 and 10, <math>0.47 \mu F</math></li> </ul>
10	Cue-Tone OUT	1.5		<ul style="list-style-type: none"> <li>• Sets cue-tone frequency</li> <li>• <math>f_{OSC} = 15</math> Hz at pins 9 and 10, <math>0.47 \mu F</math></li> <li>• Recording at head from pin 10 output</li> </ul>
11	PWR IN	1.5		<ul style="list-style-type: none"> <li>• Power input</li> <li>• Input resistor is <math>30 k\Omega</math></li> <li>• On-chip anti-buzz capacitor</li> <li>• Input to positive and negative amps with BTL power during PLAY mode</li> </ul>
12	PWR OUT1	1.2		<ul style="list-style-type: none"> <li>• Power output 1 (INVERT AMP)</li> <li>• Power output 2 (NON INVERT AMP)</li> <li>• Power output 2 only on during REC mode (single POWER)</li> </ul>
14	PWR OUT2	1.2		
13	PWR GND			
15	V <sub>CC</sub>			

Unit (resistance:  $\Omega$ , capacitance: F)

Continued on the following page.

LA4167M

Continued from the preceding page.

[ $V_{CC}=3.0V$ ,  $I_m=100mA$ ,  $R_T=100\Omega$ ]

Pin No.	Pin name	$V_{DC}$ (V)	Equivalent circuit	Remarks
16	GVN OUT	0.15 to 1.6		<ul style="list-style-type: none"> <li>Connects motor</li> </ul>
17	GVN GND			
18	$V_S$	2.78		<ul style="list-style-type: none"> <li>Connects at <math>100\Omega</math> to <math>300\Omega</math>, depending on motor characteristics</li> </ul>
19	GVN Vref	1.25		<ul style="list-style-type: none"> <li>Fixed at 1.25 V with band-gap power supply</li> </ul>
20	GVN CONT			<ul style="list-style-type: none"> <li>Controls motor speed by resistor</li> </ul>

Unit (resistance:  $\Omega$ , capacitance: F)

LA4167M

Continued from the preceding page.

[V<sub>CC</sub>=3.0V, LED Load 300Ω]

Pin No.	Pin name	V <sub>DC</sub> (V)	Equivalent circuit	Remarks
21	R/P MUTE	1.5		<ul style="list-style-type: none"> <li>• Turns on mute with application of over 1.6 V when at 3.0 V</li> </ul>
22	PAUSE	0.7		<ul style="list-style-type: none"> <li>• Turns off motor (GVN) at pin 22 GND</li> </ul>
23	R/P SW	0.7 to 2.65		<ul style="list-style-type: none"> <li>• Switches to REC mode with pin 23 MIC V<sub>CC</sub> or to PLAY mode with floating</li> </ul>
24	LED DRIVE	0.2		<ul style="list-style-type: none"> <li>• LED power supply is 10 mA typ., 15 mA max.</li> </ul>

Unit (resistance: Ω, capacitance: F)

Continued on the following page.



LA4167M

Continued from the preceding page.

[V<sub>CC</sub>=3.0V]

Pin No.	Pin name	V <sub>DC</sub> (V)	Equivalent circuit	Remarks
25	R.F OUT	1.5		<ul style="list-style-type: none"> <li>R.F OUT = 1.5 V, and can enable SVRR with external capacitor</li> </ul>
26	MIC V <sub>CC</sub>	2.65		<ul style="list-style-type: none"> <li>Reference bias for bias, preamp, R/P SW, and Vref</li> </ul>
27	V <sub>REF</sub> OUT	1.5		<ul style="list-style-type: none"> <li>Output resistance r<sub>o</sub> ≈ 10 Ω</li> </ul>
28	MIC IN	1.5		<ul style="list-style-type: none"> <li>MIC IN at pin 23 MIC V<sub>CC</sub> REC state</li> </ul>
29	EQ IN	1.5		<ul style="list-style-type: none"> <li>EQ IN at pin 23 floating PLAY state</li> </ul>
30	PRE GND			

Unit (resistance: Ω, capacitance: F)

## Description of Externally Mounted Parts

Part name	Recommended value	Description								
C1	47 $\mu$ F to 100 $\mu$ F	Coupling capacitor for $f_{OSC} = 15$ Hz signal recording head.								
C2		Record output bypass capacitor. Varies according to set manufacturer.								
C3	22 $\mu$ F to 33 $\mu$ F	NF capacitor for playback preamp and MIC amp. A value higher than recommended will delay playback and MIC amp onset, resulting in a susceptibility to popping at powerup.								
C4		Resistor setting EQ curve for playback amp. Varies according to set manufacturer.								
C5	0.1 $\mu$ F to 1.0 $\mu$ F	Coupling capacitor for playback preamp to power amp and for MIC amp to REC amp. Preamp output is positive.								
C6	0.1 $\mu$ F to 1.0 $\mu$ F	Coupling capacitor for recording signal head. REC amp output is positive.								
C7	22 $\mu$ F to 47 $\mu$ F	Capacitor controlling recovery time for ALC.								
C8	1 $\mu$ F to 4.7 $\mu$ F	Capacitor controlling VOX attack time. Be aware that an increase in capacitance causes a delay in attack time. <table border="1" data-bbox="632 703 986 853"> <thead> <tr> <th>C8</th> <th>VOX attack time</th> </tr> </thead> <tbody> <tr> <td>1<math>\mu</math>F</td> <td>10ms</td> </tr> <tr> <td>4.7<math>\mu</math>F</td> <td>42ms</td> </tr> <tr> <td>10<math>\mu</math>F</td> <td>120ms</td> </tr> </tbody> </table>	C8	VOX attack time	1 $\mu$ F	10ms	4.7 $\mu$ F	42ms	10 $\mu$ F	120ms
C8	VOX attack time									
1 $\mu$ F	10ms									
4.7 $\mu$ F	42ms									
10 $\mu$ F	120ms									
C9	22 $\mu$ F	Capacitor controlling time constant for continuing to keep governor circuit on even if VOX circuit is switched off. <table border="1" data-bbox="632 920 986 1070"> <thead> <tr> <th>C9</th> <th>VOX off time</th> </tr> </thead> <tbody> <tr> <td>1<math>\mu</math>F</td> <td>0.45s</td> </tr> <tr> <td>10<math>\mu</math>F</td> <td>2s</td> </tr> <tr> <td>22<math>\mu</math>F</td> <td>4.2s</td> </tr> </tbody> </table>	C9	VOX off time	1 $\mu$ F	0.45s	10 $\mu$ F	2s	22 $\mu$ F	4.2s
C9	VOX off time									
1 $\mu$ F	0.45s									
10 $\mu$ F	2s									
22 $\mu$ F	4.2s									
C10, C11		Capacitor controlling cue-tone OSC signal $f_{OSC}$ <table border="1" data-bbox="632 1122 1102 1272"> <thead> <tr> <th>C10,C11</th> <th><math>f_{OSC}</math></th> </tr> </thead> <tbody> <tr> <td>0.47<math>\mu</math>F</td> <td>Approx. 15Hz</td> </tr> <tr> <td>0.15<math>\mu</math>F + 0.033<math>\mu</math>F</td> <td>Approx. 40Hz</td> </tr> <tr> <td>0.047<math>\mu</math>F</td> <td>Approx. 150Hz</td> </tr> </tbody> </table>	C10,C11	$f_{OSC}$	0.47 $\mu$ F	Approx. 15Hz	0.15 $\mu$ F + 0.033 $\mu$ F	Approx. 40Hz	0.047 $\mu$ F	Approx. 150Hz
C10,C11	$f_{OSC}$									
0.47 $\mu$ F	Approx. 15Hz									
0.15 $\mu$ F + 0.033 $\mu$ F	Approx. 40Hz									
0.047 $\mu$ F	Approx. 150Hz									
C12	1000pF to 2200pF	Damping capacitor. Ceramic capacitor is recommended.								
C13	0.015 $\mu$ F to 0.033 $\mu$ F	Damping capacitor. Film capacitor is recommended.								
C14	0.22 $\mu$ F to 0.33 $\mu$ F	Damping capacitor.								
C15	0.1 $\mu$ F to 1 $\mu$ F	Earphone output variable capacitor.								
C16	0.033 $\mu$ F to 0.068 $\mu$ F	Damping capacitor. Film capacitor is recommended.								
C17	220 $\mu$ F	Power supply line decoupling capacitor.								
C18	1 $\mu$ F	Load (motor) bypass capacitor.								
C19, 20	0.1 $\mu$ F to 1 $\mu$ F	Capacitor controlling muting time.								
C21	10 $\mu$ F	Ripple filter capacitor for reference voltage sources MIC $V_{CC}$ pin 26 and $V_{REF}$ pin 27. Be aware that an increase in capacitance causes an increase in the pin 10 and pin 27 smoothing, delaying onset when the power supply is switched on.								
C22	2.2 $\mu$ F to 10 $\mu$ F	Decoupling capacitor for reference bias (MIC $V_{CC}$ ).								
C23	10 $\mu$ F to 22 $\mu$ F	Decoupling capacitor for reference bias ( $V_{REF}$ ).								
C24	3300pF to 4700pF	High-pass capacitor for MIC input.								
C25	6800pF	Damping capacitor. Ceramic capacitor is recommended.								
C26	0.033 $\mu$ F to 0.068 $\mu$ F	MIC input bias and low-pass capacitor.								

Continued on the following page.

Continued from the preceding page.

Part name	Recommended value	Description
R1		Recording amp load resistor. Varies according to set manufacturer, but 10 k $\Omega$ is recommended.
R2	100 $\Omega$	Controls voltage gain for playback preamp and mike amp. In general usage within the range of 100 to 200 $\Omega$ is recommended.
R3		EQ constant for playback preamp. Varies according to set manufacturer.
R4	10k $\Omega$	Playback amp load resistor and power input potentiometer.
R5	100k $\Omega$ to 1M $\Omega$	Controls ALC attack time.
R6	1M $\Omega$	Low-temperature operation resistor (for bias) when $f_{OSC} = 15$ Hz.
R7	20k $\Omega$	$f_{OSC}$ operation resistor. Because this oscillates in balance with on-chip resistors, a high-precision resistor is recommended.
R8	500k $\Omega$ to 1M $\Omega$	Onset speed-up resistor when $f_{OSC} = 15$ Hz.
R9	1 $\Omega$ to 10 $\Omega$	Earphone output potentiometer.
R10	100 $\Omega$ to 300 $\Omega$	Varies according to motor characteristics.
R11, R12		Resistor controlling motor speed. Motor speed is adjusted with R11 (fixed) and R12 (variable). Varies according to motor characteristics and set manufacturer.
R13, 14	10k $\Omega$ to 30k $\Omega$	Mute bias resistor
R15	100 $\Omega$ to 300 $\Omega$	LED drive current control resistor. LED if off only when cue-tone is on.
R16	3k $\Omega$	Resistor controlling ALC width.
R17	10k $\Omega$ to 20k $\Omega$	MIC input bias resistor.
R18	5k $\Omega$ to 20k $\Omega$	Controls internal mike output level. Varies according to set manufacturer.
R19	6.8k $\Omega$	Control recording head DC bias current. 6.8 $\Omega$ is recommended when recording with DC bias system. Be aware that when resistance is high, bias current shows a tendency to diminish, and when resistance is made low, the playback head level is decreased during playback.

## IC Usage Cautions and Explanation of Operation

- (1) Playback preamp and power amp voltage gain distribution during playback

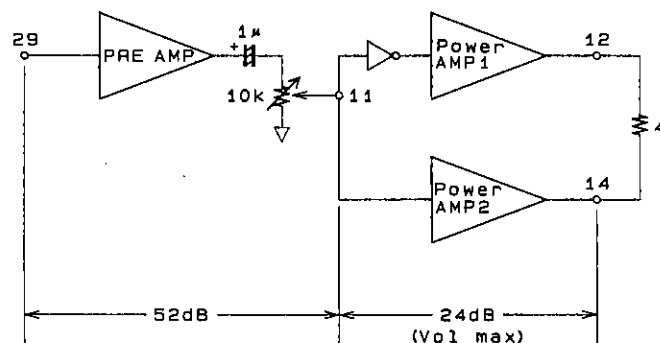

Unit (resistance:  $\Omega$ , capacitance: F)

- The voltage gain of the preamp can be adjusted by resistor R2, connected externally. In this case, be aware that varying the voltage gain causes the voltage gain for the playback preamp and the mike amp to be each varied simultaneously.

(2) Mike amp, REC amp, and power amp voltage gain distribution during recording

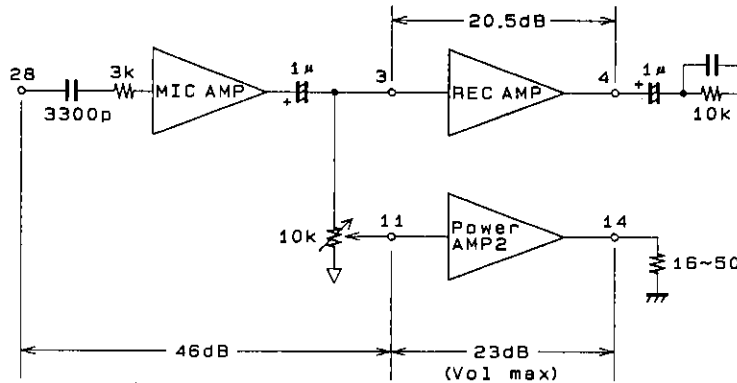

A00725

Unit (resistance: Ω, capacitance: F)

- Be aware that during recording, the power amp is not BTL, and there is single operation for only power amp 2.

(3) VOX circuit (VOX equivalent circuit)

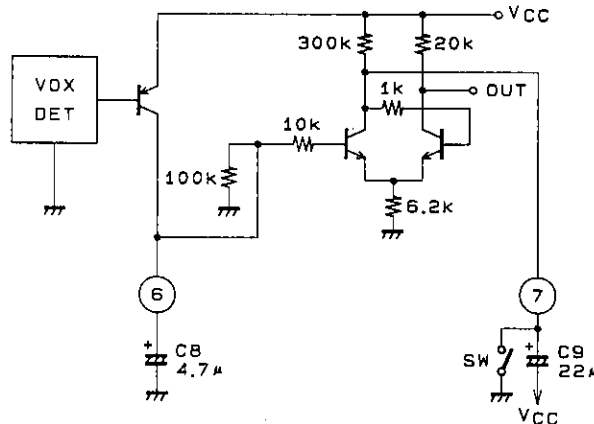

A00725

Unit (resistance: Ω, capacitance: F)

- VOX on time can be adjusted by varying C8 at pin 6. Increasing the capacitance delays attack time, and reducing capacitance hastens it (VOX on = Approx. 40 ms when C8 = 4.7 μF and C9 = 22 μF).
- VOX off time can be adjusted by varying C9 at pin 7 (VOX off = Approx. 4s when C8 = 4.7 μF and C9 = 22 μF).
- To continue VOX circuit operation when MIC input is below the specified level, increase the capacitance of the capacitor between pin 7 and VCC.
- To keep the governor circuit on after the VOX circuit is switched off, turn on the switch and ground pin 7 in the equivalent circuit shown above.
- Only a capacitor is mounted between pin 6 and ground. A resistor is not mounted because when the VOX circuit is turned on, a minute charging current is present at pin 6, and the resistance would bypass this minute current, causing a delay in operation and, in the worst case, failure of the VOX circuit to operate.

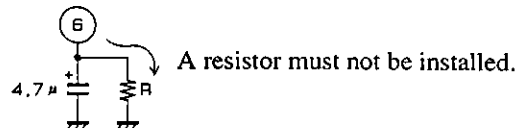

A00727

- The VOX circuit has a hysteresis width of approximately 6 dB. But as shown in the figure above, the VOX circuit is switched on when the voltage at pin 6 is over approximately 1.3 V, and is switched off when voltage is below approximately 0.7 V. The bias to keep the VOX circuit on at this time must be an average or smooth voltage over approximately 0.75 V.

(4) Cue-tone (externally mounted cue-tone circuit)

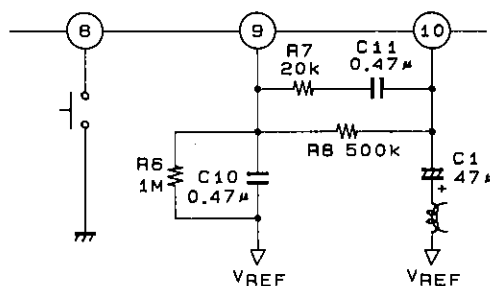

A00728

Unit (resistance: Ω, capacitance: F)

- Cue-tone begins to operate at the pin 8 ground, as shown in the figure above. The LED goes out at this time.
- Capacitors C10 and C11 for cue-tone operation must be of high quality and of identical precision.
- Capacitors C10 and C11 can be varied to change the cue-tone frequency. Increasing the capacitance of C10 and C11 delays the frequency, and decreasing this capacitance hastens it. In the external circuit shown above,  $f_{OSC} = \text{Approx. } 15 \text{ Hz}$ .

(5) R/P mute (mute circuit during R/P switching)

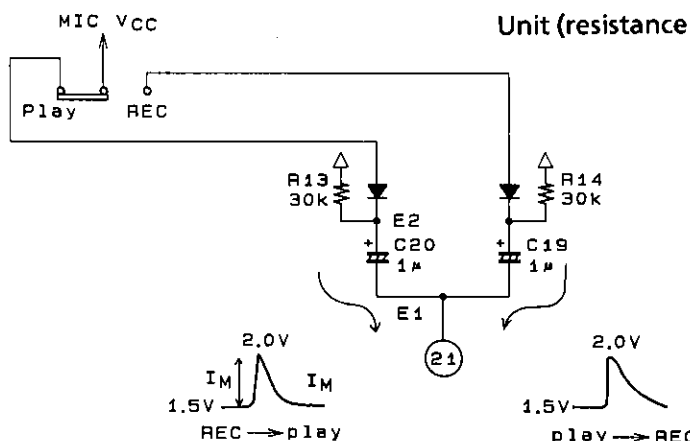

Unit (resistance: Ω, capacitance: F)

A00729

- In the mute circuit depicted above, a minute pulse is input to pin 21 as shown in the figure to switch from REC to PLAY or from PLAY to REC. At this time, current is determined by:

$$I_M = \frac{E_2 - E_1}{R_{13}}$$

In this case,

$$I_M = \frac{2.0V - 1.5V}{30k\Omega} = 16.7\mu A$$

- Muting capacitors C19 and C20 are used to adjust the muting time: muting time increases when capacitance is high and decreases when capacitance is low. Be aware, however, that if capacitance is excessive, power amp onset is delayed when  $V_{CC}$  is on. Capacitance of  $0.1 \mu F$  to  $1 \mu F$  is recommended.
- If voltage over  $1.6 \text{ V}$  is applied to the mute pin when  $V_{CC} = 3.0 \text{ V}$ , each amp is muted. Be aware that application of voltage higher than  $V_{CC}$  in this case will disable muting.
- The power, REC, VOX, and ALC amps can be muted.

(6) LEDs

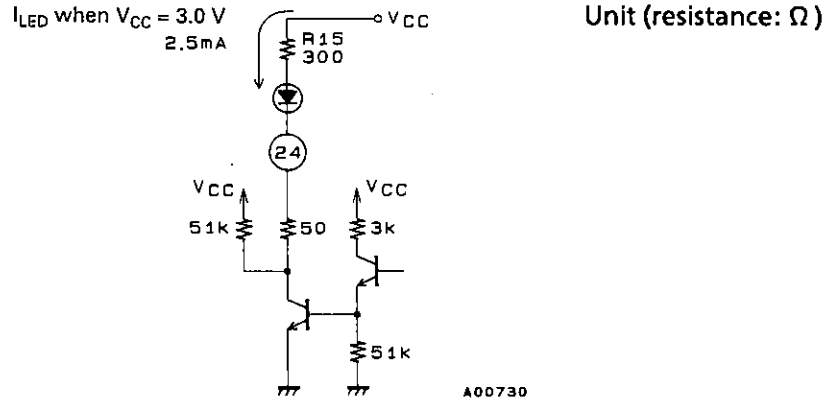

- Pin 24 is dedicated to LED use. The LED is lit during normal operation, and goes out only when cue-tone is in the recording mode.
- With 10 mA typ. at 3.0 V for  $I_{LED}$  at the LED pin, it is possible to switch between red and green LEDs as shown in the diagram below.

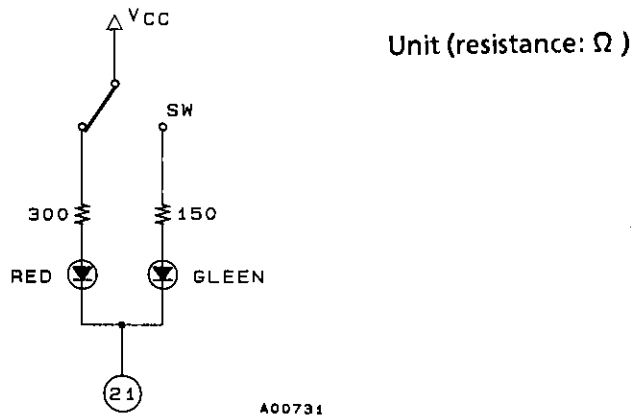

- The LED pin should be left open if not used.

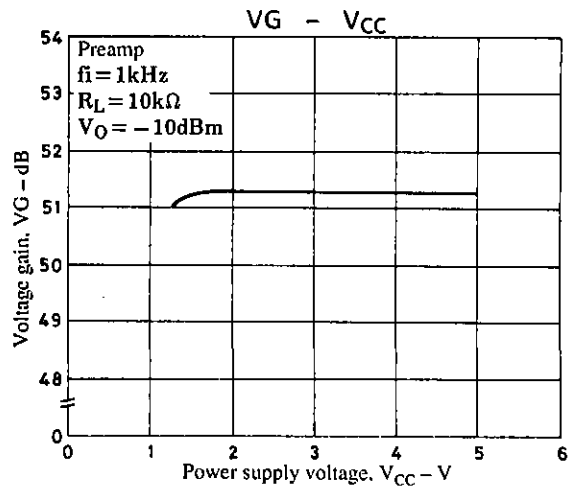
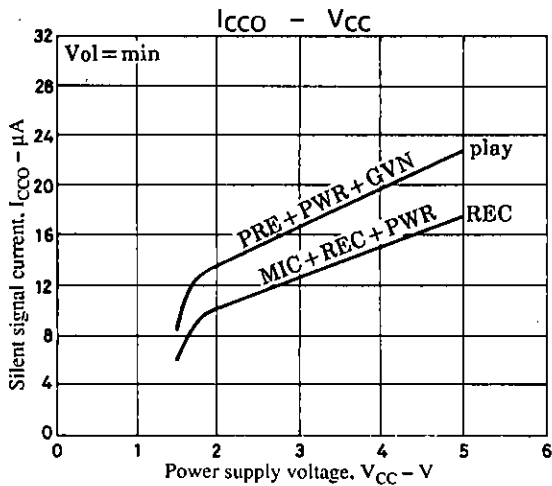

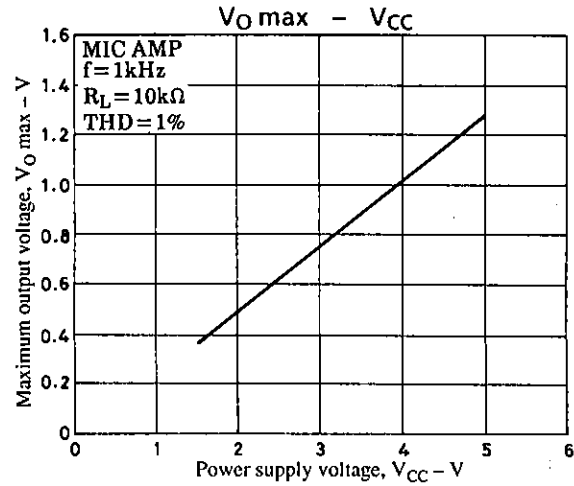
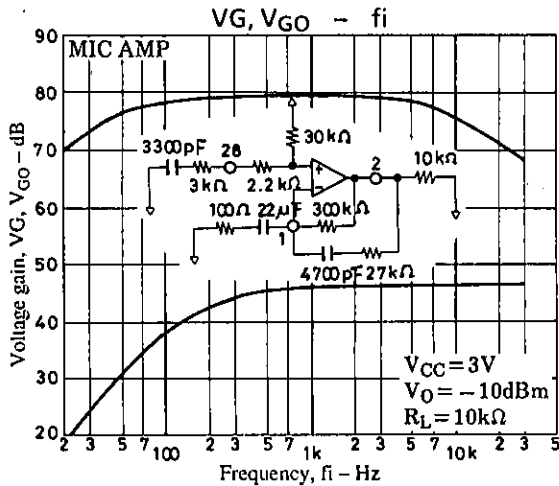
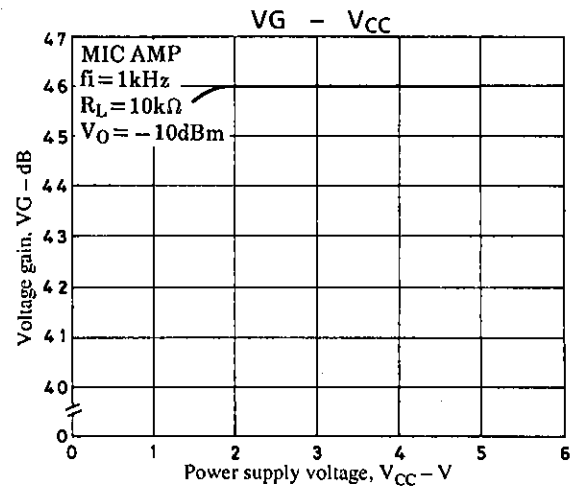
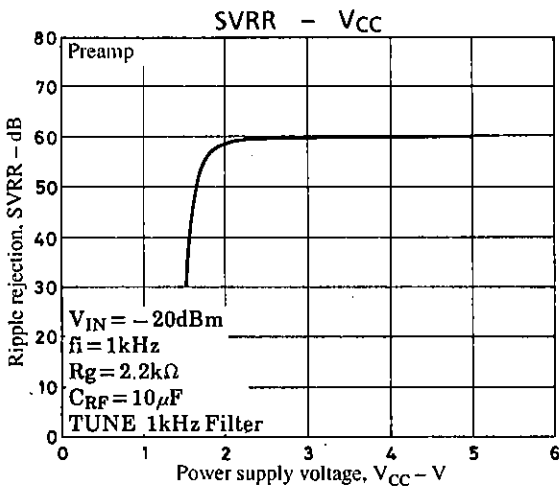
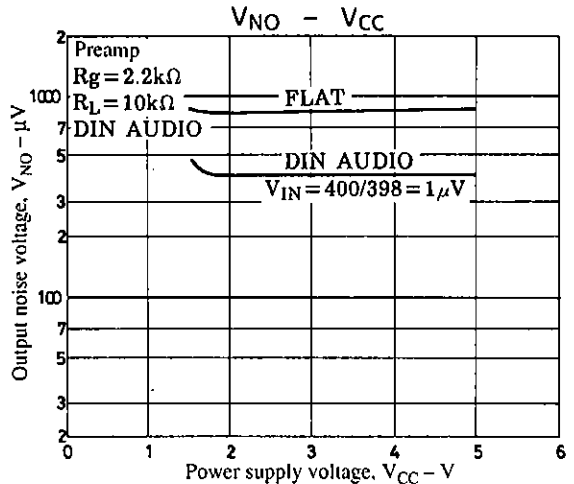
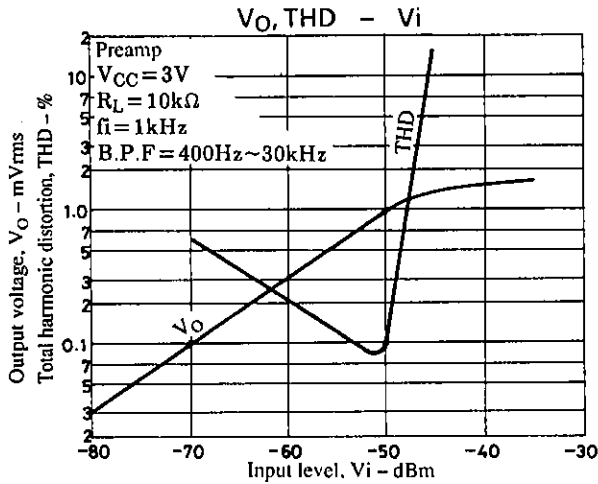
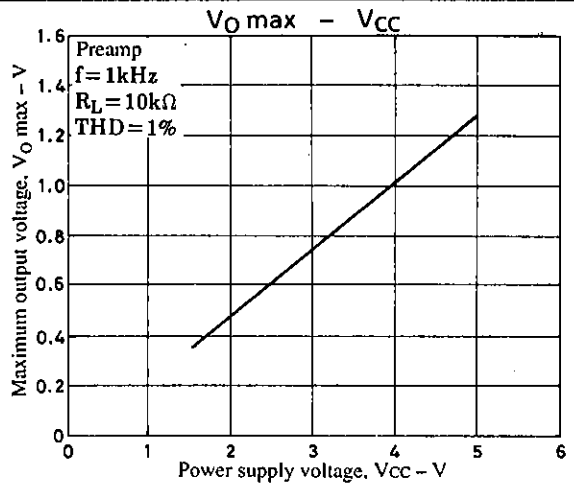
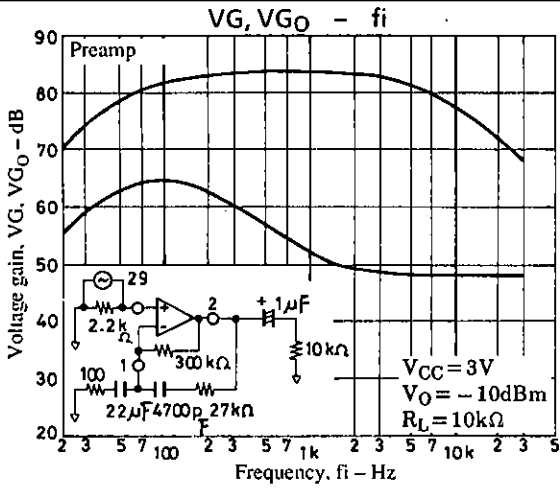

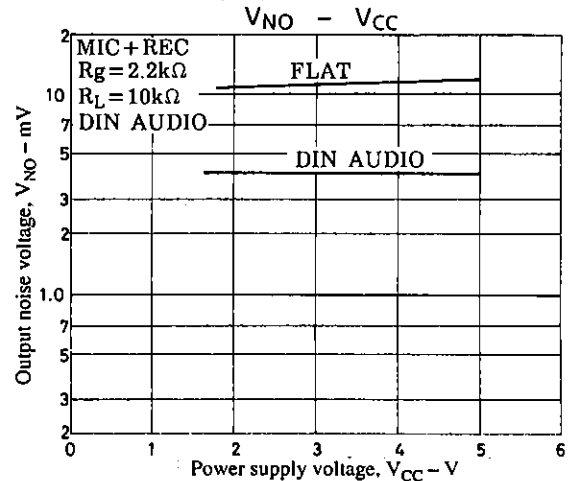
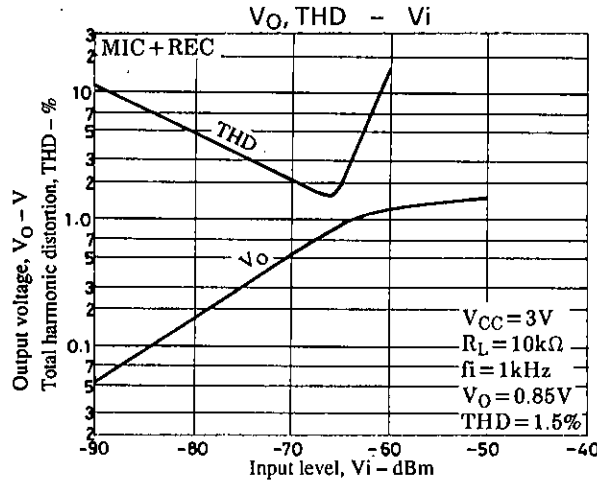
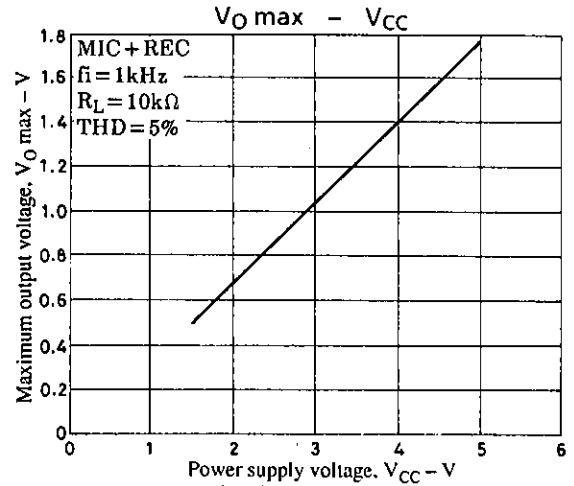
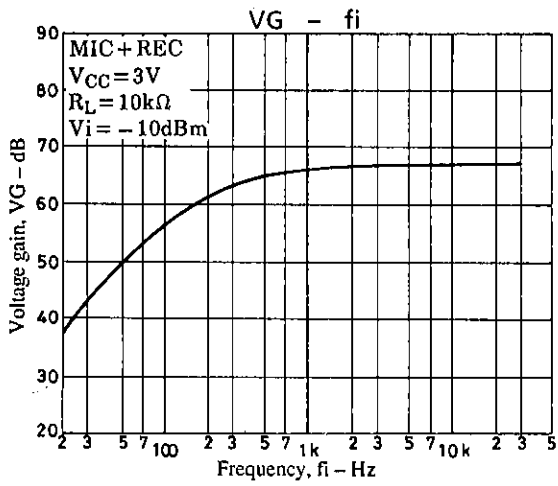
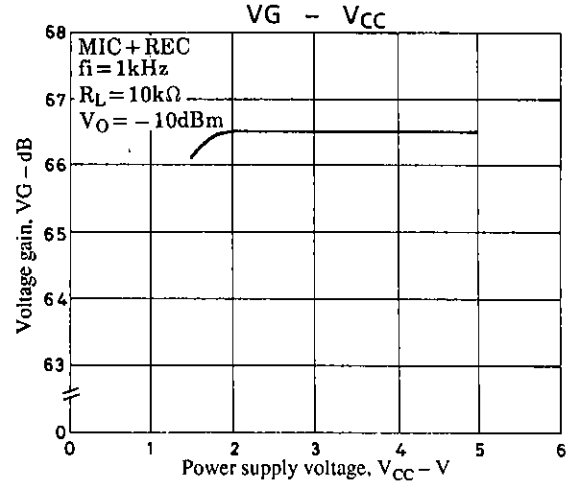
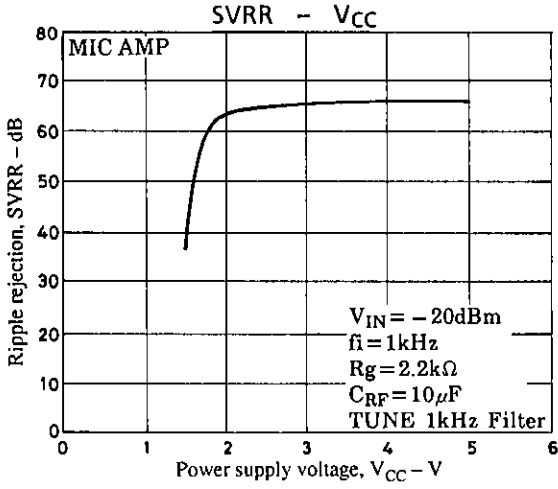
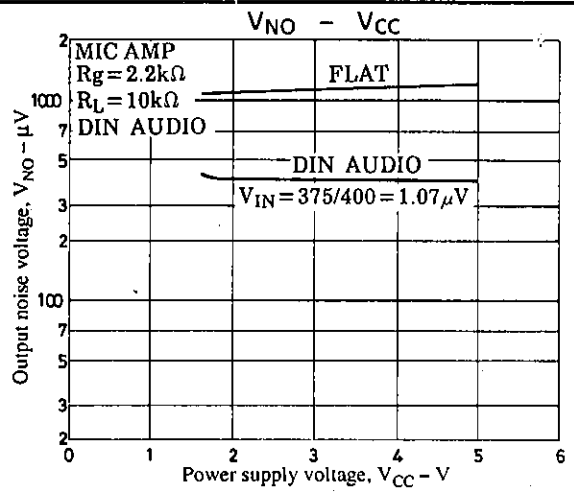
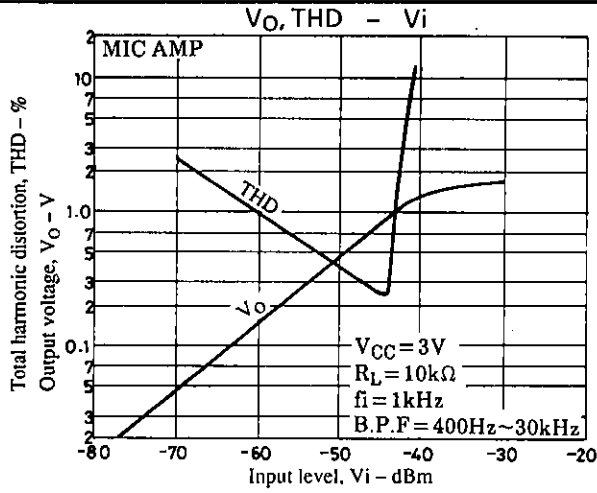



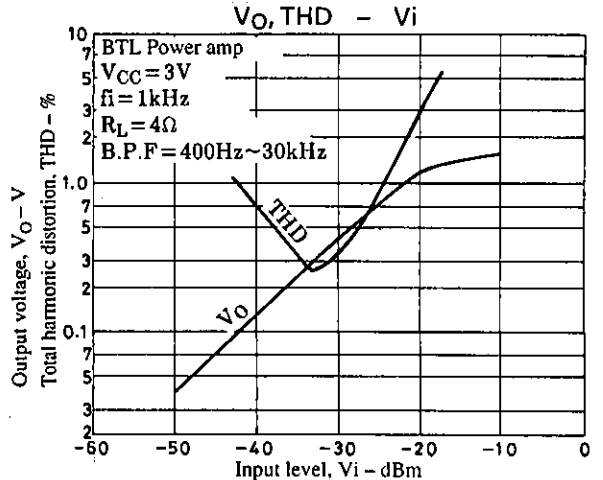
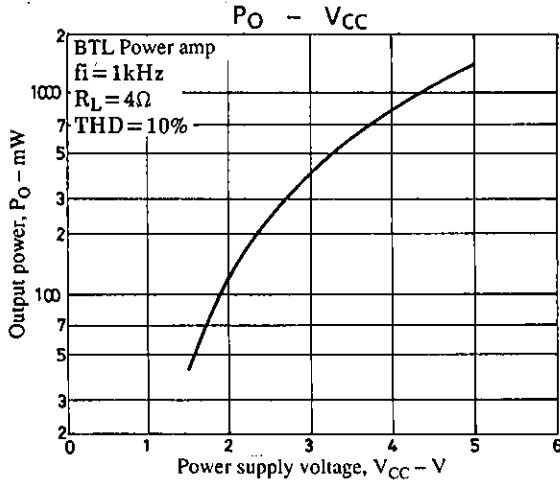
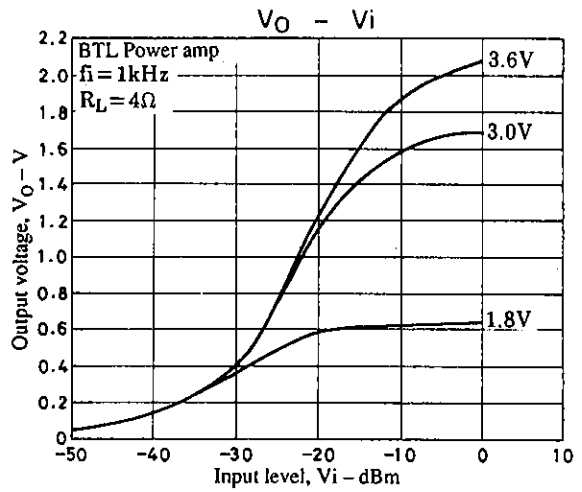
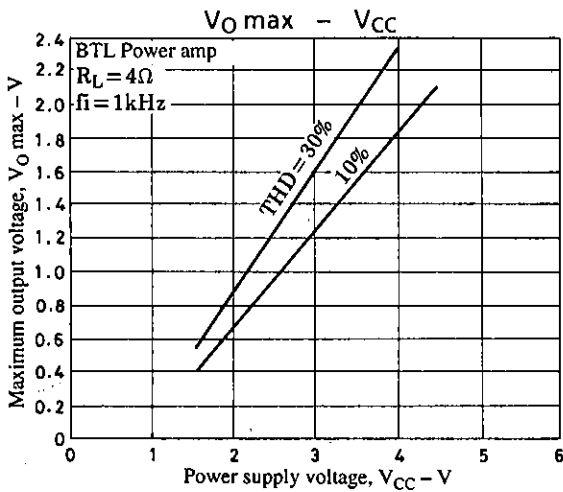
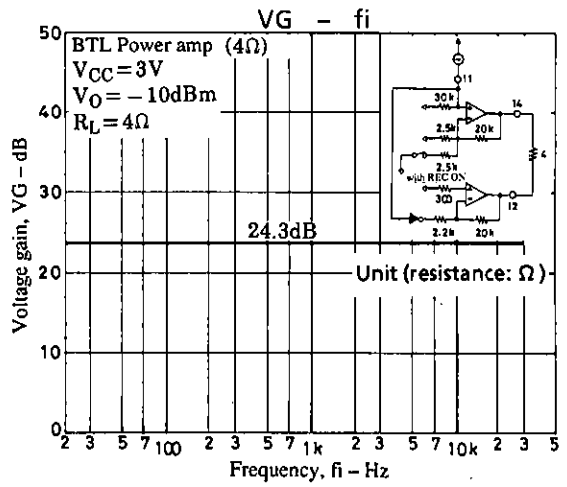
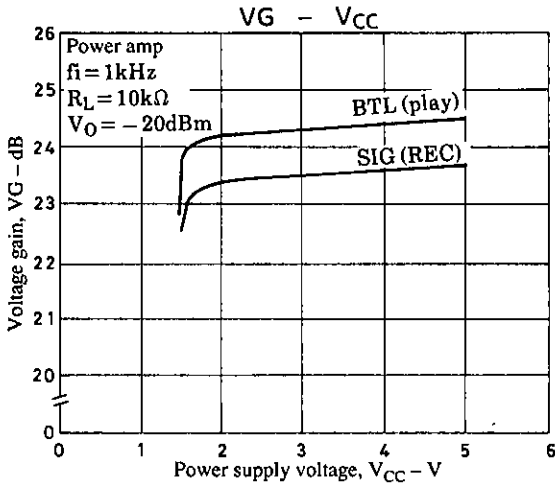
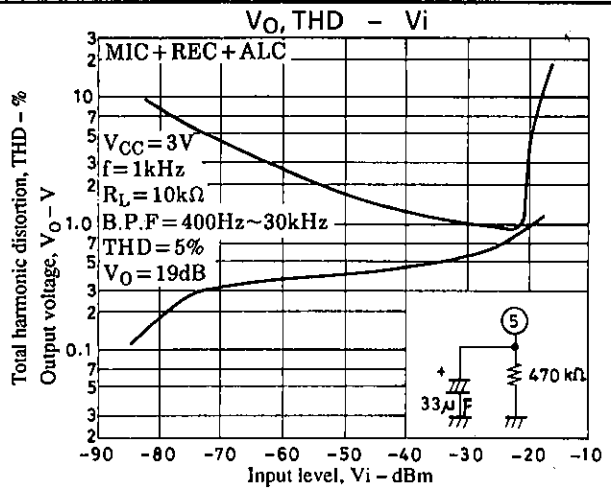
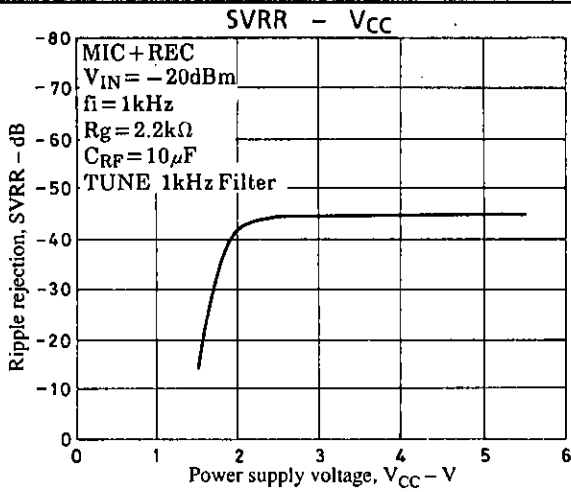

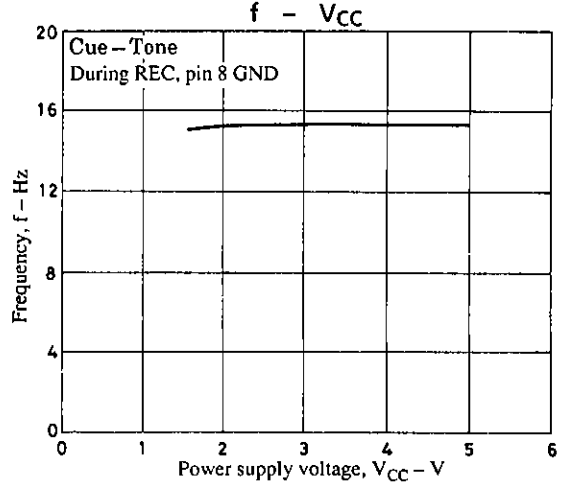
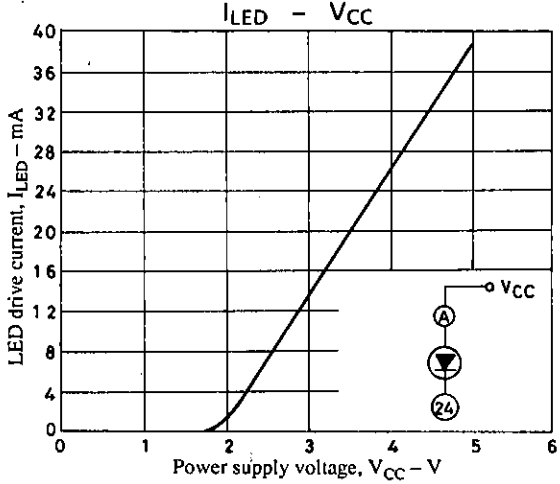
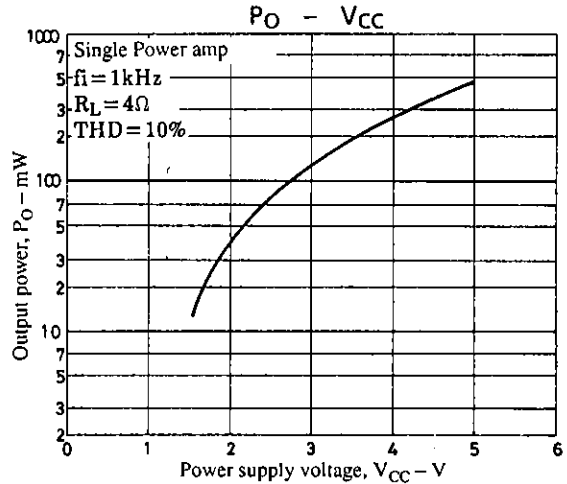
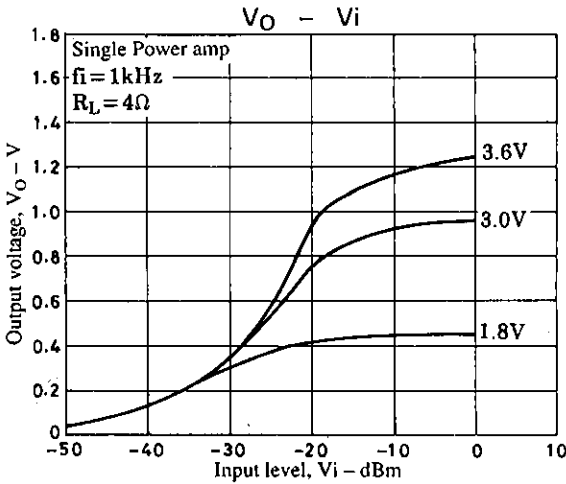
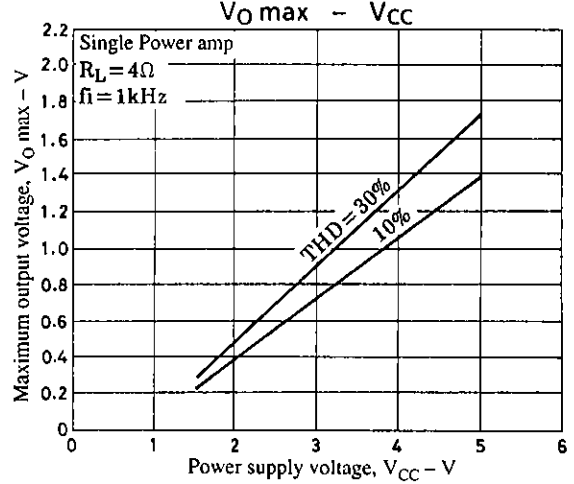
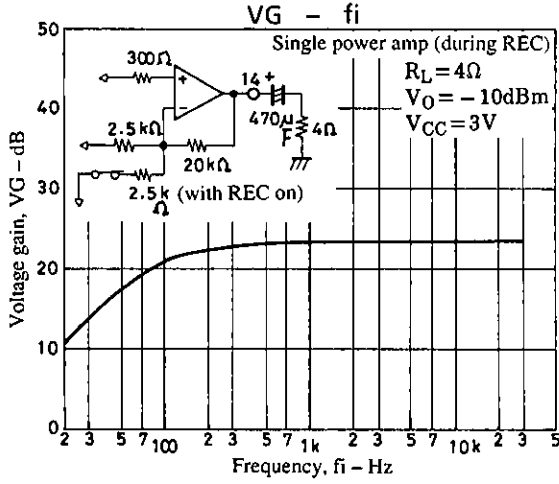
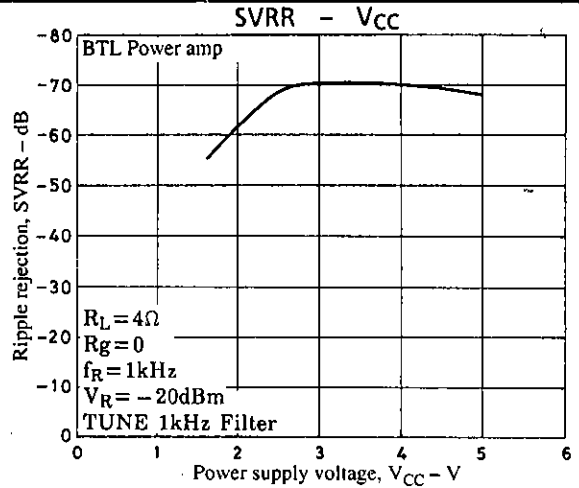
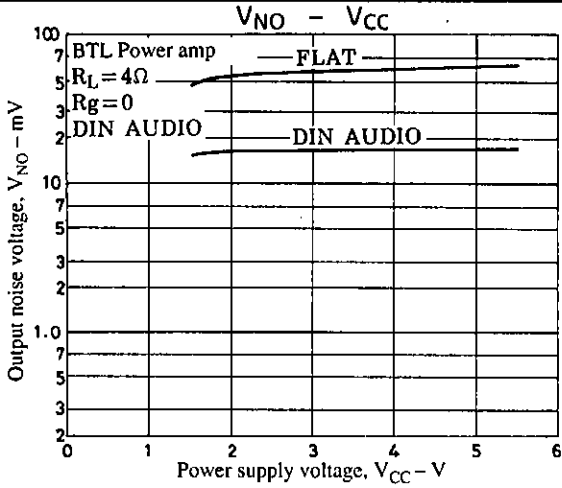

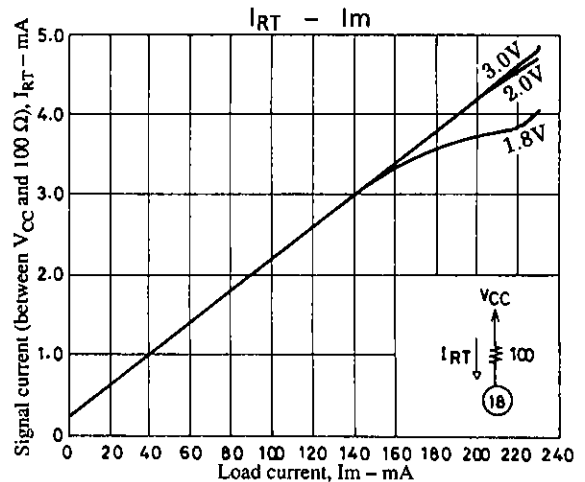
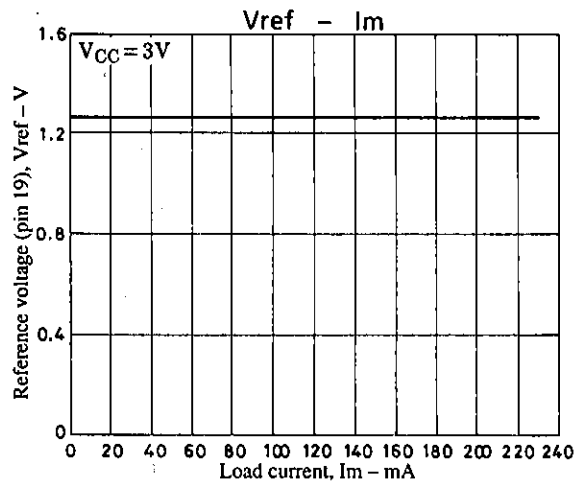
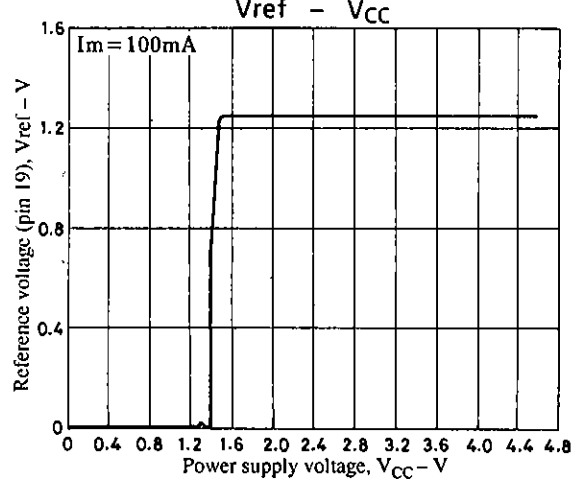
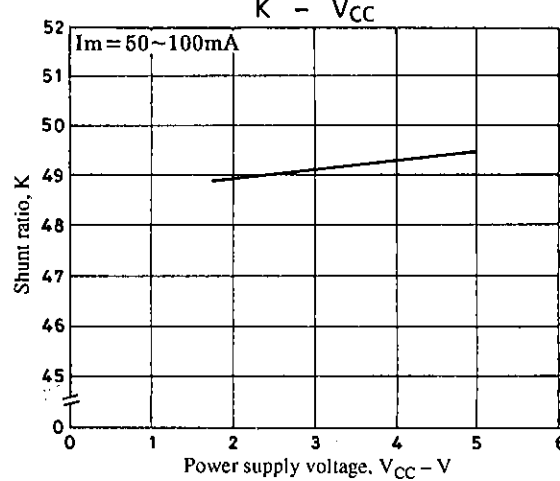
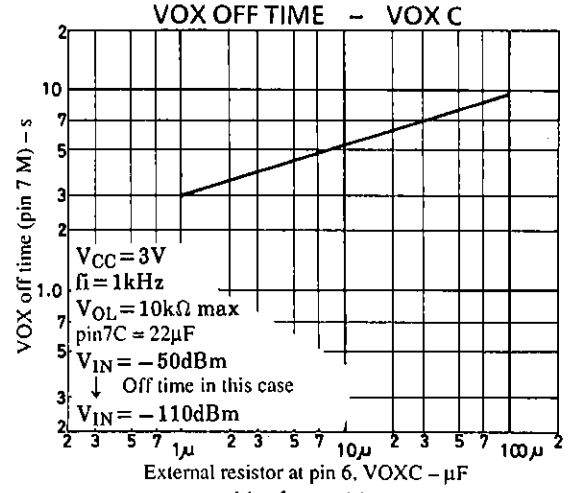
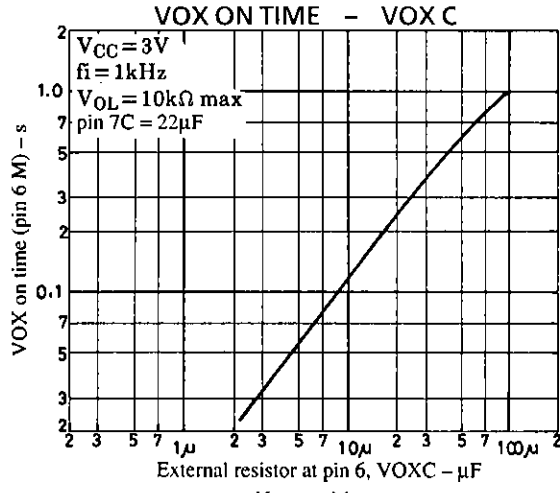
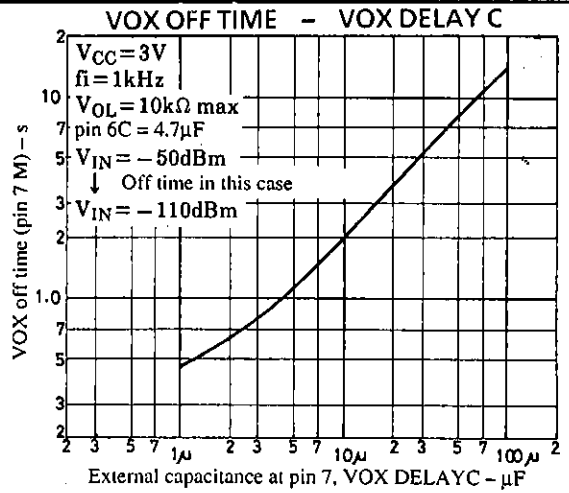
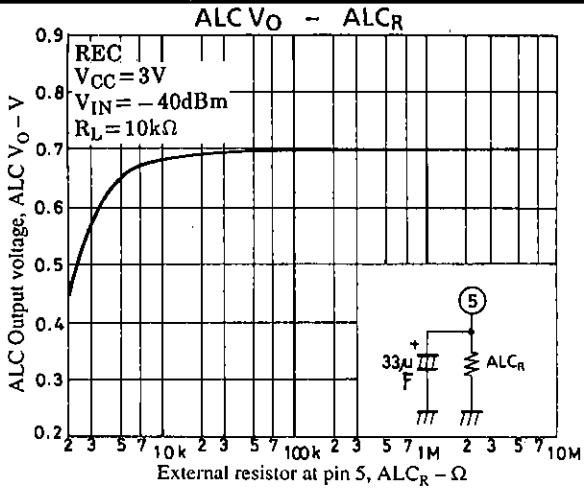

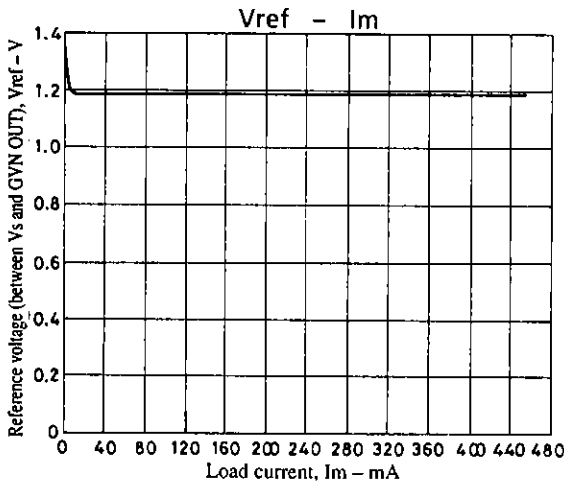
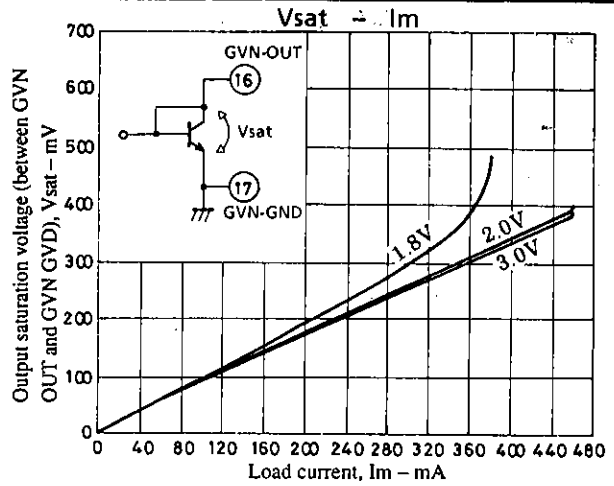
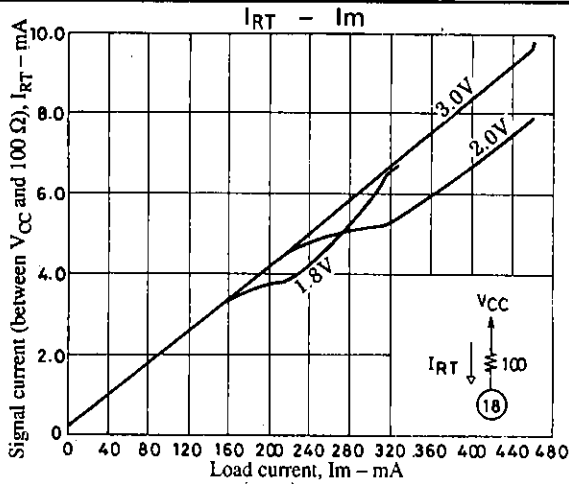

- No products described or contained herein are intended for use in surgical implants, life-support systems, aerospace equipment, nuclear power control systems, vehicles, disaster/crime-prevention equipment and the like, the failure of which may directly or indirectly cause injury, death or property loss.
- Anyone purchasing any products described or contained herein for an above-mentioned use shall:
  - ① Accept full responsibility and indemnify and defend SANYO ELECTRIC CO., LTD., its affiliates, subsidiaries and distributors and all their officers and employees, jointly and severally, against any and all claims and litigation and all damages, cost and expenses associated with such use;
  - ② Not impose any responsibility for any fault or negligence which may be cited in any such claim or litigation on SANYO ELECTRIC CO., LTD., its affiliates, subsidiaries and distributors or any of their officers and employees jointly or severally.
- Information (including circuit diagrams and circuit parameters) herein is for example only; it is not guaranteed for volume production. SANYO believes information herein is accurate and reliable, but no guarantees are made or implied regarding its use or any infringements of intellectual property rights or other rights of third parties.