

5 CHANNELS VIDEO SWITCH

- EACH CHANNEL EXCEPT FAST BLANKING HAS 6dB GAIN
- R, G, B AND VIDEO SIGNALS ARE CLAMPED TO THE SAME REFERENCE VOLTAGE IN ORDER TO HAVE NO OUTPUT DIFFERENTIAL VOLTAGE WHEN SWITCHING
- ALL INPUT LEVELS COMPATIBLE WITH NFC 92250 AND EN 50049 NORMS
- 30MHz BAND WIDTH FOR R, G, B SIGNALS
- INTERNAL 6.7V SHUNT REGULATOR FOR :
 - LOW IMPEDANCE LOADS,
 - POWER DISSIPATION LIMITATION
- THE FIVE CHANNELS ARE SIMULTANEOUSLY SWITCHED BY ONLY ONE SELECT INPUT

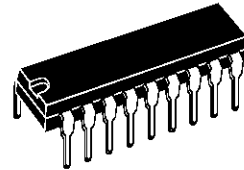

DIP18
(Plastic Package)

ORDER CODE : TEA5116

PIN CONNECTIONS

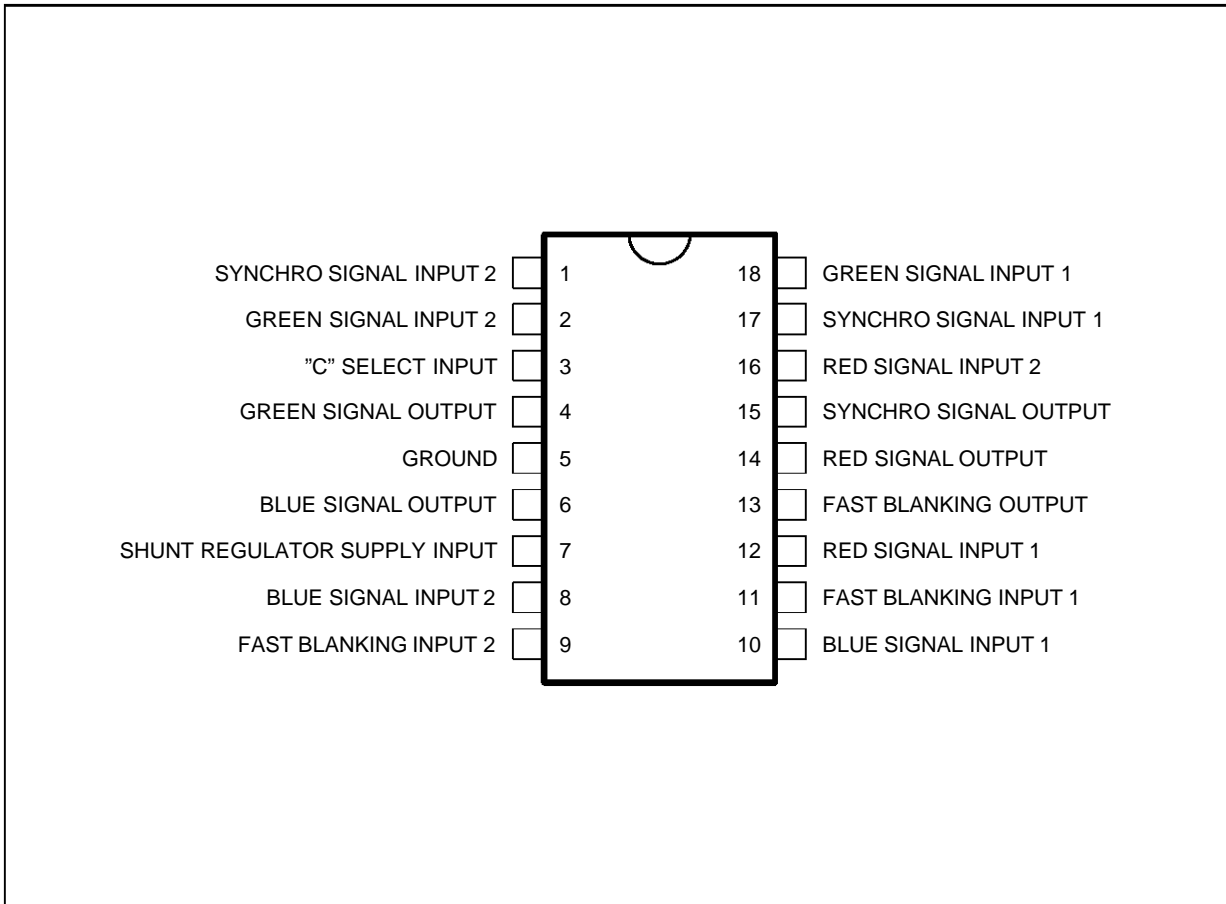

5116-01.EPS

BLOCK DIAGRAM

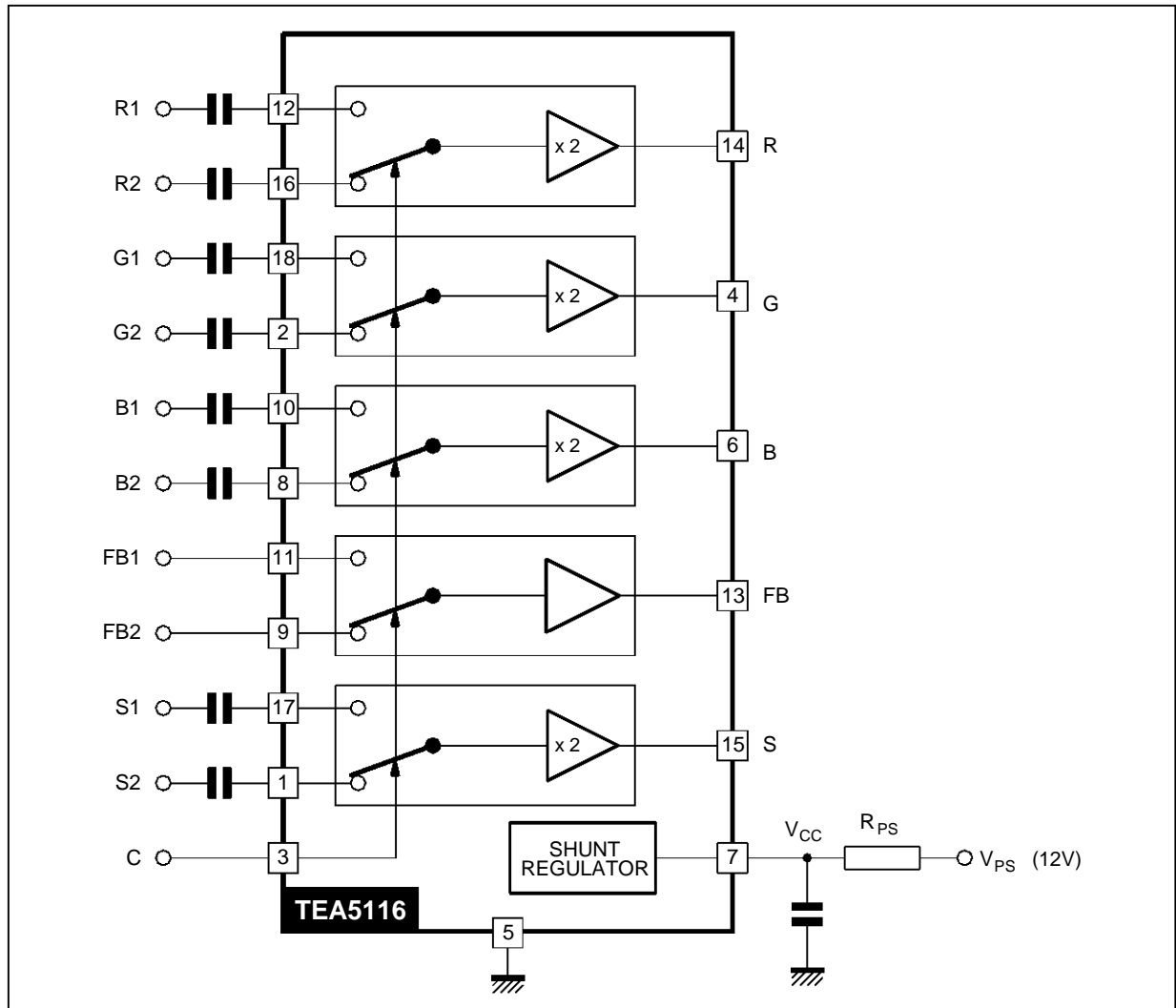

5116-02.EPS

ABSOLUTE MAXIMUM RATINGS

Symbol	Parameter	Value	Unit
I_{CC}	Supply Current (see note)	150	mA
V_{in}	Input Voltage (all inputs)	- 0.5 to V_{CC} + 0.5	V
T_{oper}	Operating Temperature Range	0, 70	°C
T_j	Junction Temperature	- 40, + 150	°C
T_{stg}	Storage Temperature	- 40, + 150	°C

Note : Minimum output load is 300 Ω in case of all outputs loaded.

5116-01.TBL

THERMAL DATA

Symbol	Parameter	Value	Unit
$R_{th(j-a)}$	Junction-ambient Thermal Resistance	70	°C/W

5116-01.TBL

ELECTRICAL CHARACTERISTICS

$T_{amb} = + 25\text{ }^{\circ}\text{C}$, $I_{CC} = 120\text{ mA}$; Load value = $150\text{ }\Omega$

(sequentially switched) (unless otherwise specified, refer to test circuit page 7)

Symbol	Parameter	Min.	Typ.	Max.	Unit	
V_{CC}	Internal Shunt Regulator	$I_{CC} = 120\text{ mA}$	6.3	6.7	7.2	V
		$I_{CC} = 90\text{ mA}$	6.2		7.3	V
		$I_{CC} = 150\text{ mA}$	6.2		7.3	V

R, G, B Switches (pins 4, 6, 14) (Time Measurement Conditions : Δ inputs RGB = 0.7 V_{pp} ; C pulse amplitude = 3 V)

V_C	DC Output Voltage (no input voltage)	$T_{junction} = 25\text{ }^{\circ}\text{C}$ $T_{junction}$ stabilized		0.9 1.2	1.25	V
V_{AC}	Max Output Swing Voltage		2	4		V_{pp}
B	Bandwidth (-3 dB) (input voltage 0.7 V_{pp})		20	30		MHz
A_v	Gain of Each Channel (input voltage 0.7 V_{pp} ; $f = 1\text{ MHz}$)		5.5	6	6.5	dB
A_{dc}	Gain Difference between any two R, G, B Channels (input voltage 0.7 V_{pp} ; $f = 1\text{ MHz}$)			0.1	0.5	dB
	Input Swing			$0.7\text{ V} \pm 3\text{ dB}$		
Z_{ic}	DC Input Impedance			10		$\text{k}\Omega$
Z_{oc}	Dynamic Output Impedance (input voltage 0.7 V_{pp} ; $f = 1\text{ MHz}$) with $R_{load} = 300\Omega$			10		Ω
	Crosstalk between any inputs (R1 and R2 or B1 and B2 or G1 and G2) (input voltage 0.7 V_{pp} ; $f = 1\text{ MHz}$).		45	55		dB
	Crosstalk between any outputs (input voltage 0.7 V_{pp} ; $f = 1\text{ MHz}$)		40	55		dB
t_{dc}	Delay time between R, G, B inputs and RGB outputs.			10		ns
t_{sr1}	Switching Rise Time between FB1 Input Signal and R, G, B Output Signal (input signal on RGB1)			45		ns
t_{sf1}	Switching Fall Time between FB1 Input Signal and R, G, B Output Signal (input signal on RGB1)			25		ns
t_{sr2}	Switching Rise Time between FB2 Input Signal and R, G, B Output Signal (input signal on RGB2)			55		ns
t_{sf2}	Switching Fall Time between FB2 Input Signal and R, G, B Output Signal (input signal on RGB2)			25		ns

Fast Blanking Switch (pin 13)

(time measurement conditions : FB input pulse amplitude = 2 V , C pulse amplitude = 3 V)

V_{IL}	Low Level Input Voltage	$T_{junction} = 25\text{ }^{\circ}\text{C}$ $T_{junction}$ stabilized	-0.5		0.4	V
V_{IH}	High Level Input Voltage		1		$V_{CC}+0.5$	V
V_{OL}	Low Level Output Voltage				$V_{CC}+0.5$	V
V_{OH}	High Level Output Voltage		1.4 1.5	1.7 1.9	3.5	V V
	Dynamic Output Impedance : with $R_{load} = 300\Omega$			10		Ω
t_{FB1r}	Delay Rise Time between FB1 Input and FB Output			60	110	ns
t_{FB1f}	Delay Fall Time between FB1 Input and FB Output			40	60	ns
t_{FB2r}	Delay Rise Time between FB2 Input and FB Output			60		ns
t_{FB2f}	Delay Fall Time between FB2 input and FB Output			40		ns
t_{SFB1r}	Switching Rise Time between C Input and FB Output (input signal on FB1 input)			75		ns
t_{SFB1f}	Switching Fall Time between C Input and FB Output (input signal on FB1 input)			50		ns
t_{SFB2r}	Switching Rise Time between C Input and FB Output (input signal on FB2 input)			85		ns
t_{SFB2f}	Switching Fall Time between C Input and FB Output (input signal on FB2 input)			50		ns

5116-03.TBL

ELECTRICAL CHARACTERISTICS (continued)

Symbol	Parameter	Min.	Typ.	Max.	Unit
Video (or synchro) Signal Switch (pin 15) - time measurement conditions : (C pulse amplitude = 3V)					
V _S	DC Output Voltage (no input voltage)		0.9 1.2	1.25	V V
V _{as}	Max Output Swing Voltage	2.6			V _{pp}
Z _{ic}	DC Input Impedance		10		kΩ
Z _{cc}	Dynamic Output Impedance (input voltage 1V _{pp} ; f = 1MHz) with R _{load} = 300 Ω		10		Ω
A _V	Gain (input voltage 1 V _{pp} ; f = 1MHz)	5.5	6	6.5	dB
B	Bandwidth (- 3 dB) (input voltage 1 V _{pp})	15	20		MHz
	Input Swing		1V ± 3 dB		
t _{dc}	Delay Time between S Input and S Output (Δ input : 0.7V _{PP})		10		ns
t _{sr1}	Switching rise time between C input signal and S output signal (input signal on S1)		45		ns
t _{sf1}	Switching fall time between C input signal and S output signal (input signal on S1)		25		ns
t _{sr2}	Switching Rise time between C input signal and S output signal (input signal on S2)		55		
t _{sf2}	Switching fall time between C input signal and S output signal (input signal on S2)		25		

Select Input "C" (pin 3)

V _{IL}	Low Level Input Voltage	- 0.5		1	V
V _{IH}	High Level Input Voltage	2		V _{CC} +0.5	V
I _{IL}	Low Level Input Current (V _{IL} = 1 V)	- 0.6		- 0.1	mA
I _{IH}	High Level Input Current (V _{IH} = 3 V)			0.5	mA

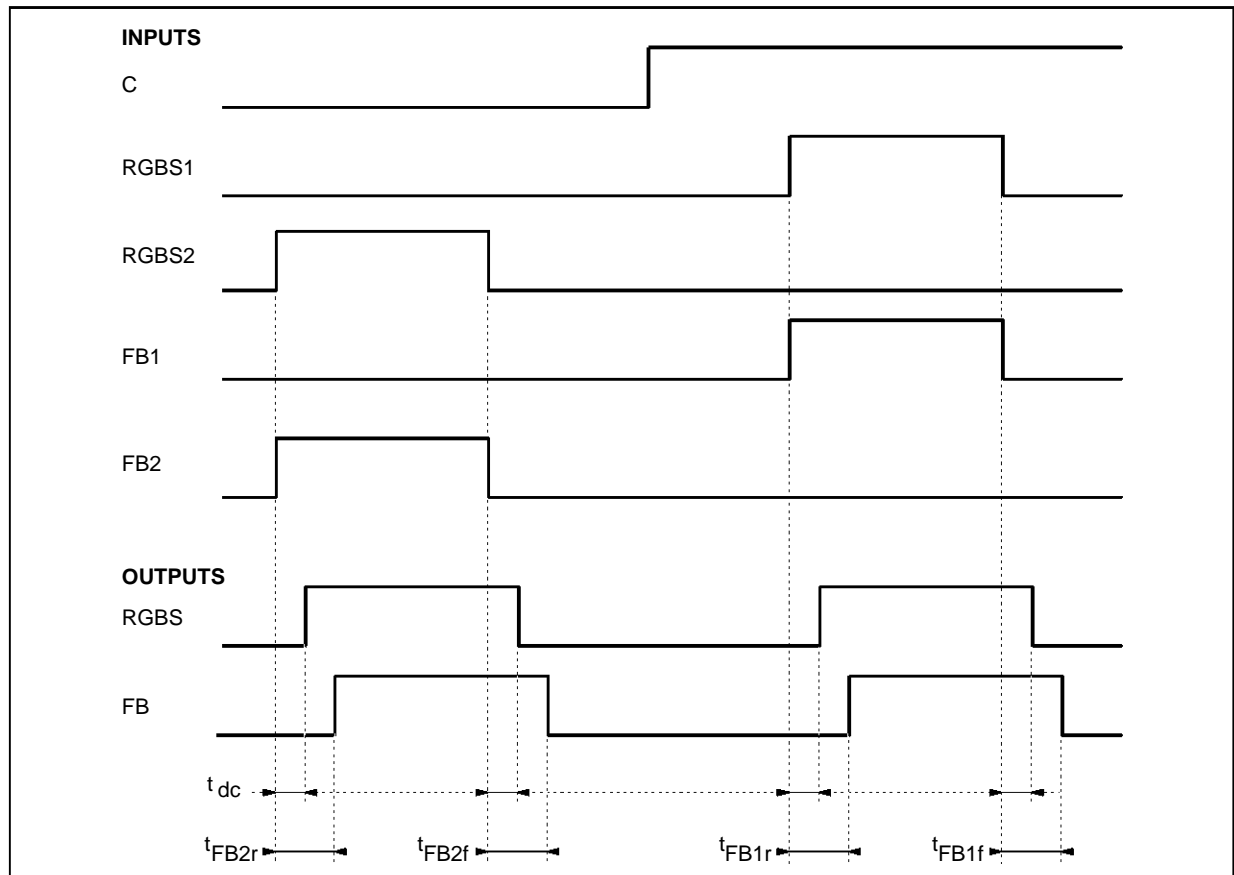

RGBS2 = 0, FB2 = 0

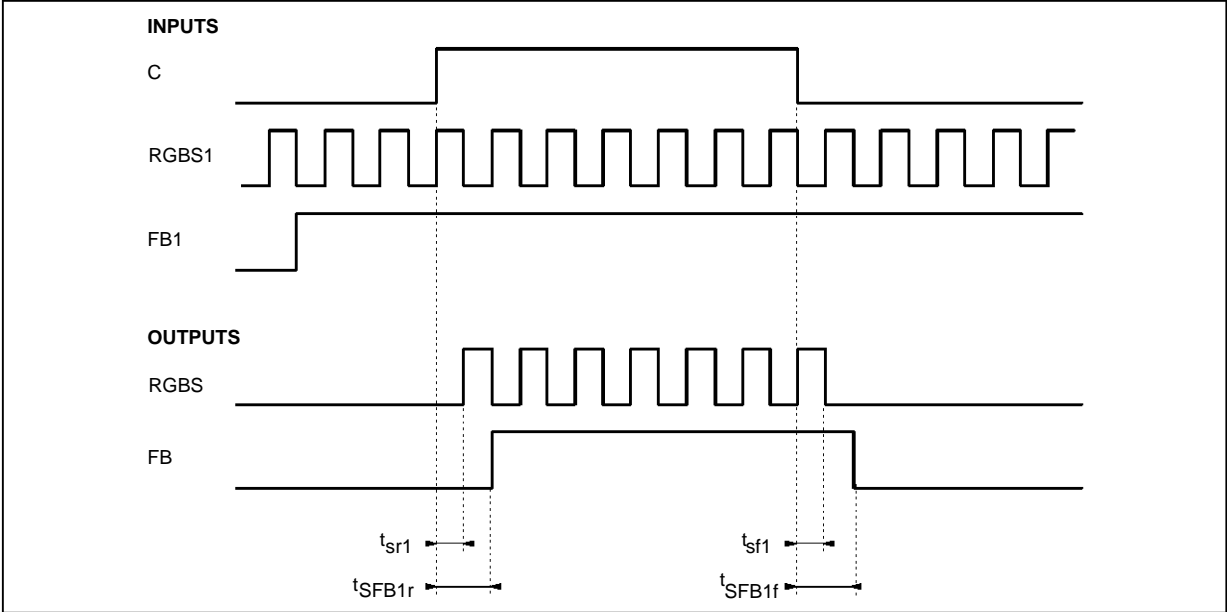

RGBS1 = 0, FB1 = 0

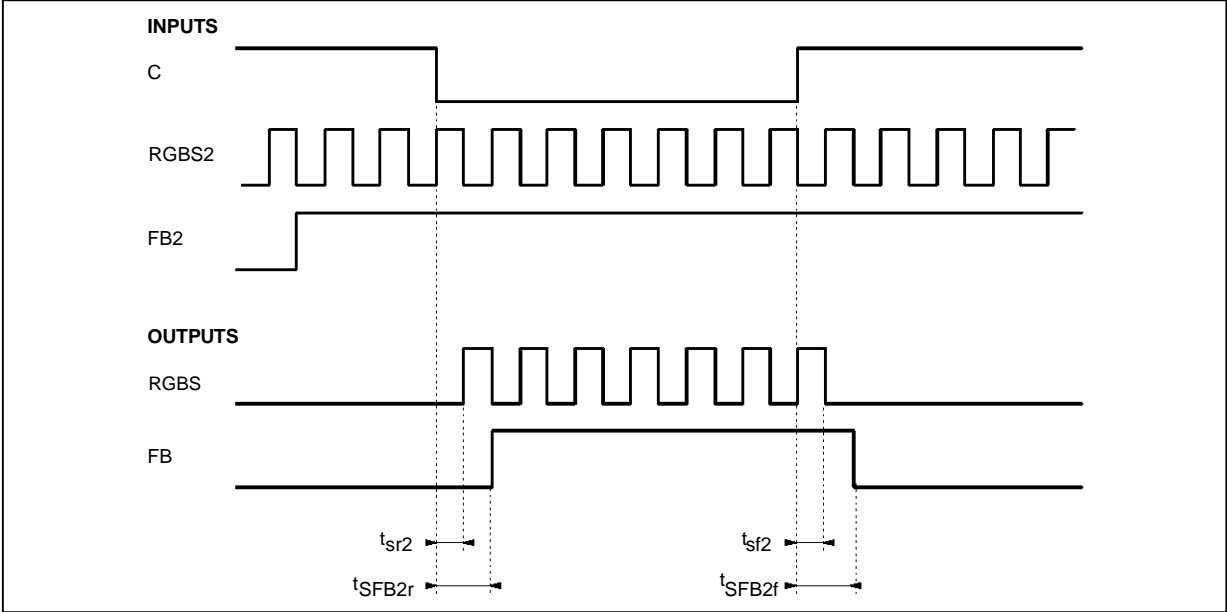

TEST CIRCUIT

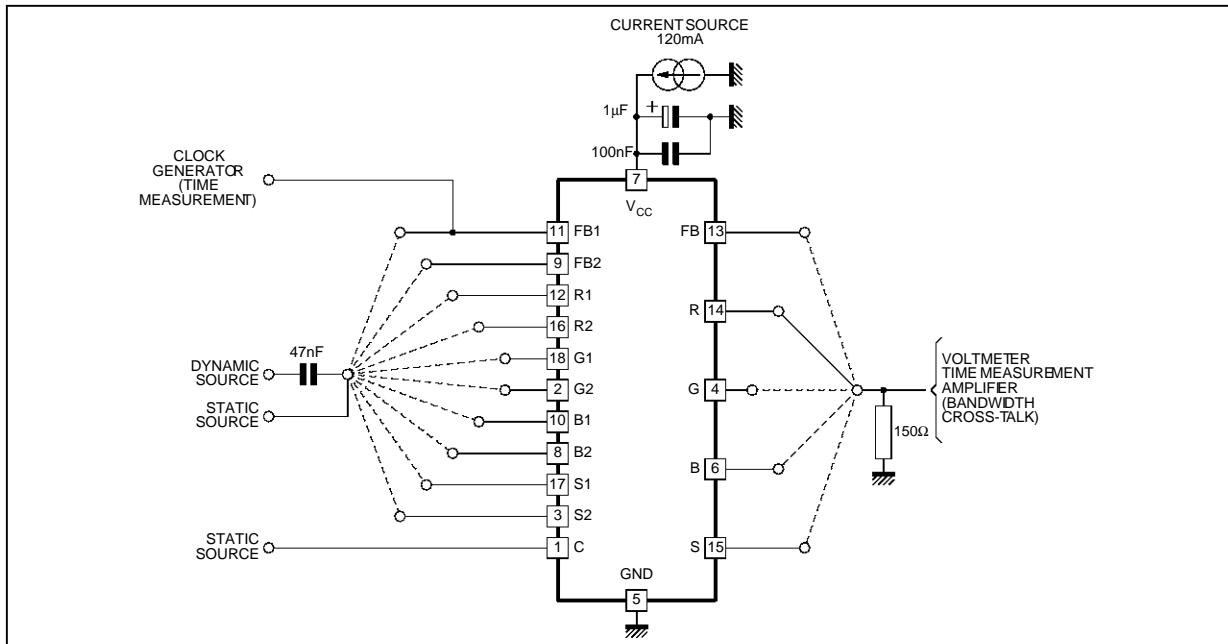

5116-06.EPS

INPUTS/OUTPUTS EQUIVALENT INTERNAL DIAGRAMS

R, G, B, S inputs (pins 1, 2, 8, 10, 12, 16, 17, 18)

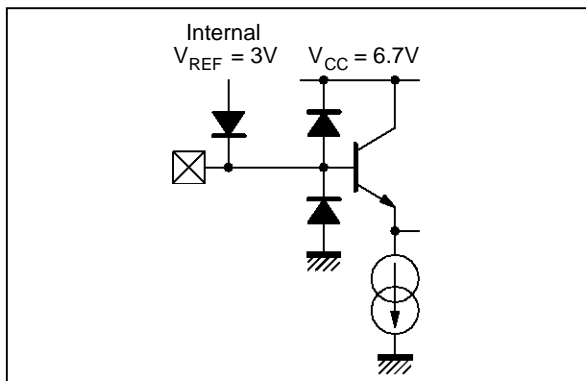

5116-07.EPS

FB inputs (pins 9, 11)

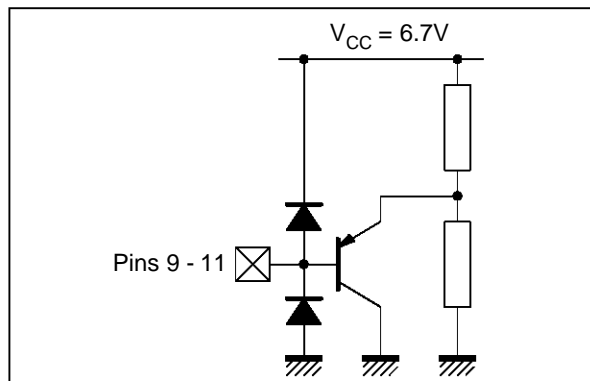

5116-08.EPS

C input (pin 3)

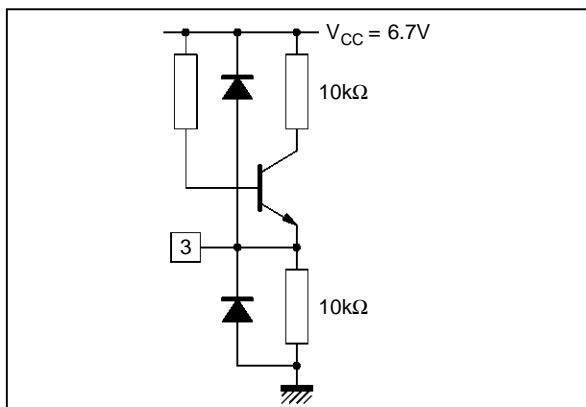

5116-09.EPS

All Outputs (pins 4, 6, 13, 14, 15)

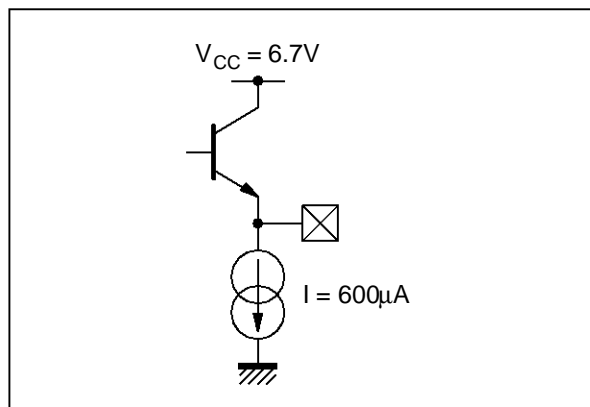

5116-10.EPS

INPUTS/OUTPUTS EQUIVALENT INTERNAL DIAGRAMS (continued)

I_{CC} Supply (shunt transistor regulation system) (Pin 7)

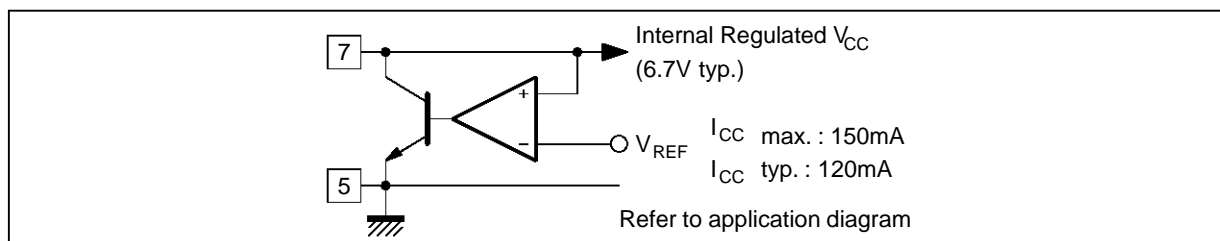

5116-11.EPS

TYPICAL APPLICATION DIAGRAM

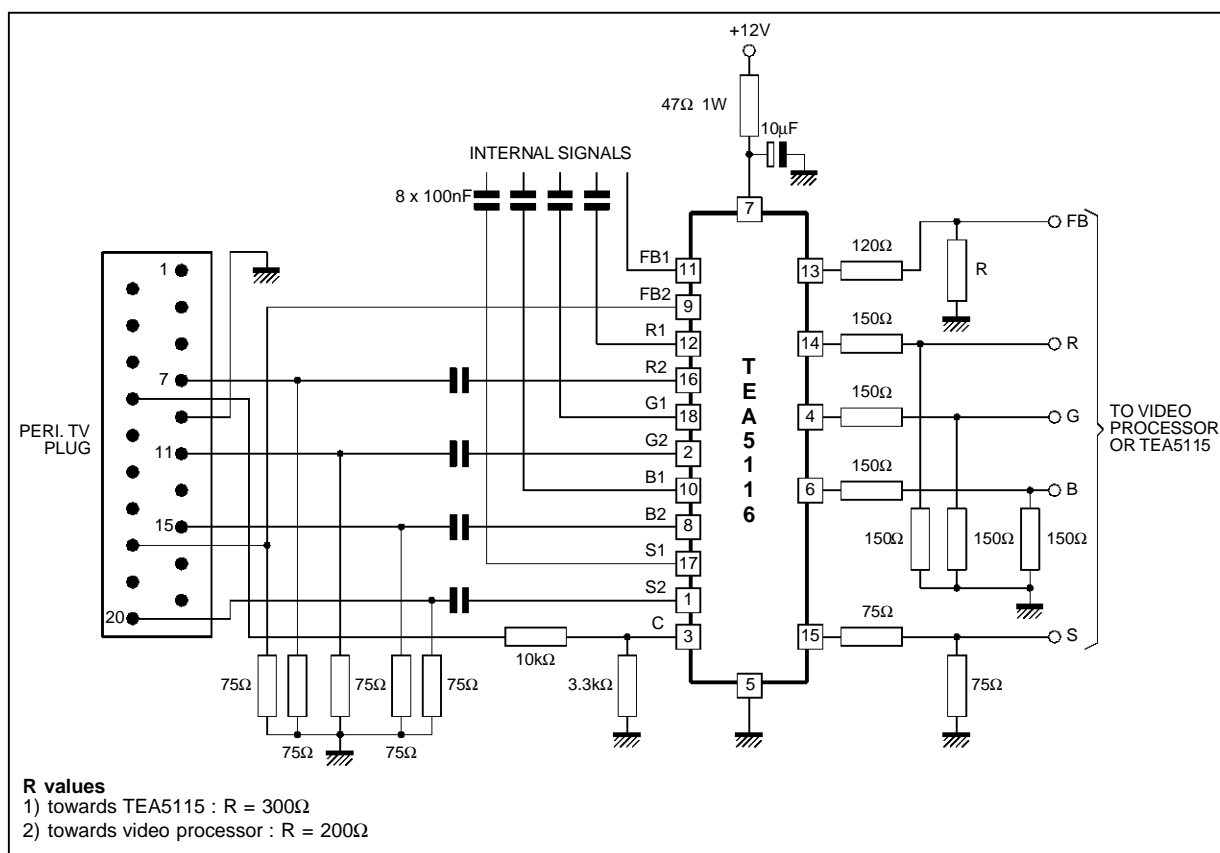

5116-12.EPS

- Above given output load values are minimum values, in case of all output loading.
- Minimum output load is 150 Ω individually, provided that total supply current is less than 150 mA.

PACKAGE MECHANICAL DATA
18 PINS – PLASTIC DIP

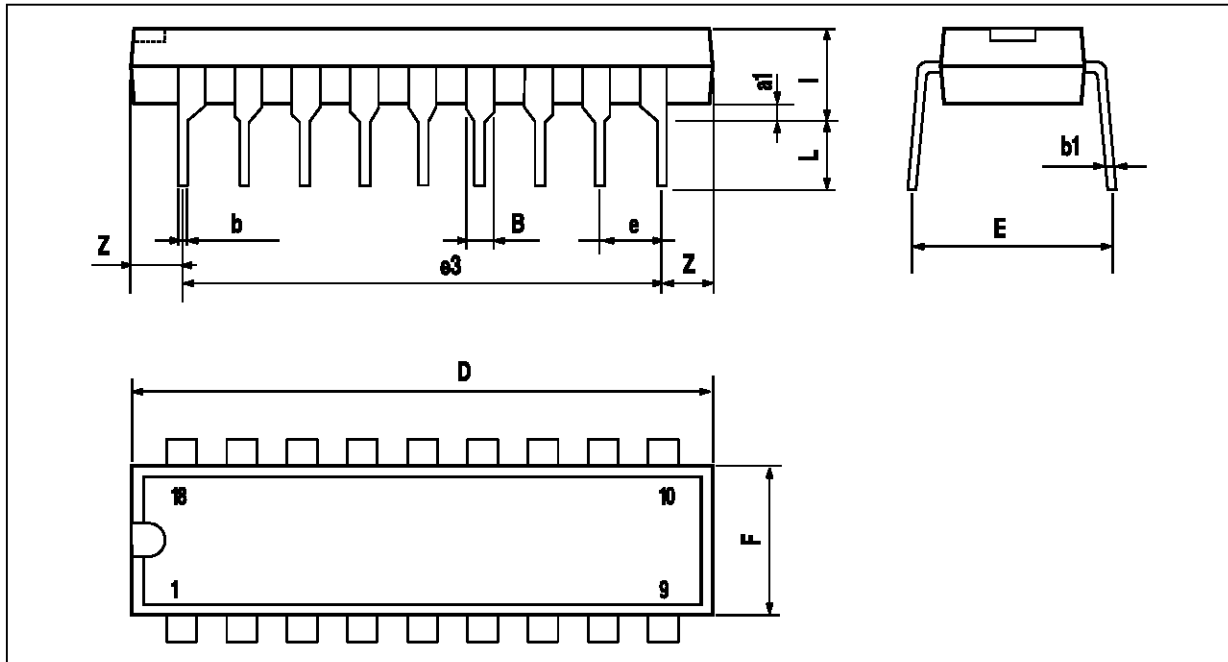

PM-DIP18.EPS

Dimensions	Millimeters			Inches		
	Min.	Typ.	Max.	Min.	Typ.	Max.
a1	0.254			0.010		
B	1.39		1.65	0.055		0.065
b		0.46			0.018	
b1		0.25			0.010	
D			23.24			0.915
E		8.5			0.335	
e		2.54			0.100	
e3		20.32			0.800	
F			7.1			0.280
l			3.93			0.155
L		3.3			0.130	
Z		1.27	1.59		0.050	0.063

DIP18.TBL

Information furnished is believed to be accurate and reliable. However, SGS-THOMSON Microelectronics assumes no responsibility for the consequences of use of such information nor for any infringement of patents or other rights of third parties which may result from its use. No licence is granted by implication or otherwise under any patent or patent rights of SGS-THOMSON Microelectronics. Specifications mentioned in this publication are subject to change without notice. This publication supersedes and replaces all information previously supplied. SGS-THOMSON Microelectronics products are not authorized for use as critical components in life support devices or systems without express written approval of SGS-THOMSON Microelectronics.

© 1996 SGS-THOMSON Microelectronics - All Rights Reserved

Purchase of I²C Components of SGS-THOMSON Microelectronics, conveys a license under the Philips I²C Patent. Rights to use these components in a I²C system, is granted provided that the system conforms to the I²C Standard Specifications as defined by Philips.

SGS-THOMSON Microelectronics GROUP OF COMPANIES

Australia - Brazil - Canada - China - France - Germany - Hong Kong - Italy - Japan - Korea - Malaysia - Malta - Morocco
The Netherlands - Singapore - Spain - Sweden - Switzerland - Taiwan - Thailand - United Kingdom - U.S.A.