

HORIZONTAL AND VERTICAL PROCESSOR

- 503kHz REFERENCE OSCILLATOR
- 5.5V SUPPLY VOLTAGE INTERNALLY REGULATED
- VERY SOPHISTICATED SYNC. SEPARATOR
- COUNT DOWN TIMING LOGIC
- ADAPTS AUTOMATICALLY TO 625 LINE/50Hz AND 525 LINE/60Hz STANDARDS
- 50/60 Hz IDENTIFICATION OUTPUT
- AUTOMATIC VERTICAL AMPLITUDE CORRECTION 50/60Hz
- CRT PROTECTION CIRCUIT
- PHASE-CORRECTED HORIZONTAL OUTPUT WITH CONSTANT DUTY CYCLE

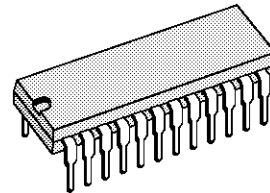

DIP24
(Plastic Package)

ORDER CODE : TDA8185I

DESCRIPTION

The TDA8185I is a monolithic integrated circuit in 24 pins dual in line plastic package intended for TV signal processing and driving Horizontal and Vertical output stages. It was specially designed for VCR working conditions.

PIN CONNECTIONS

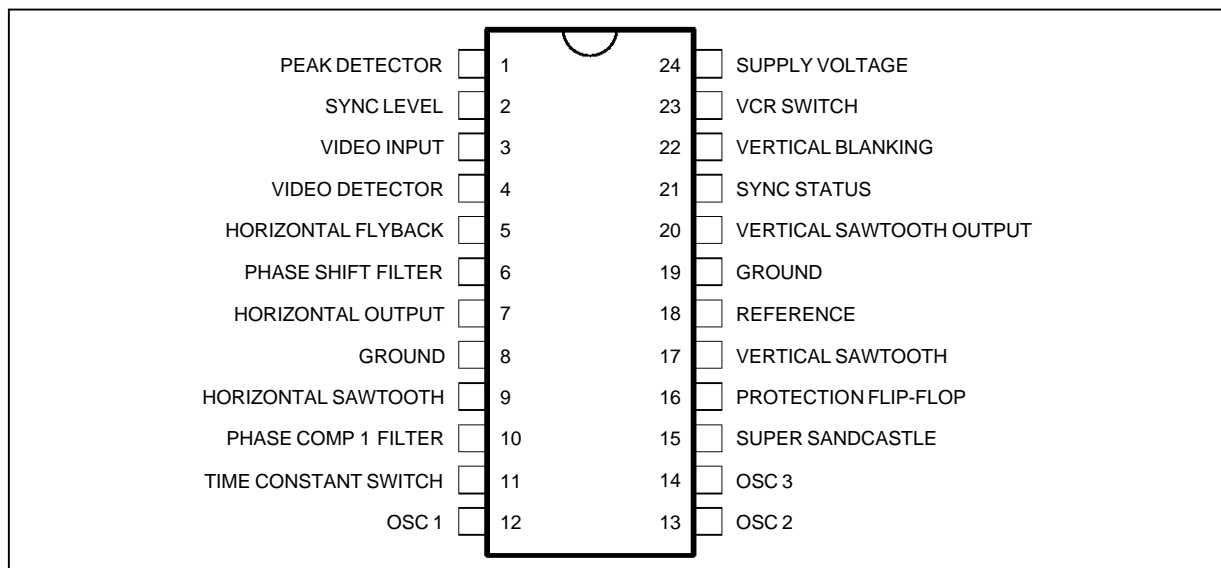

8185I-01.EPS

BLOCK DIAGRAM

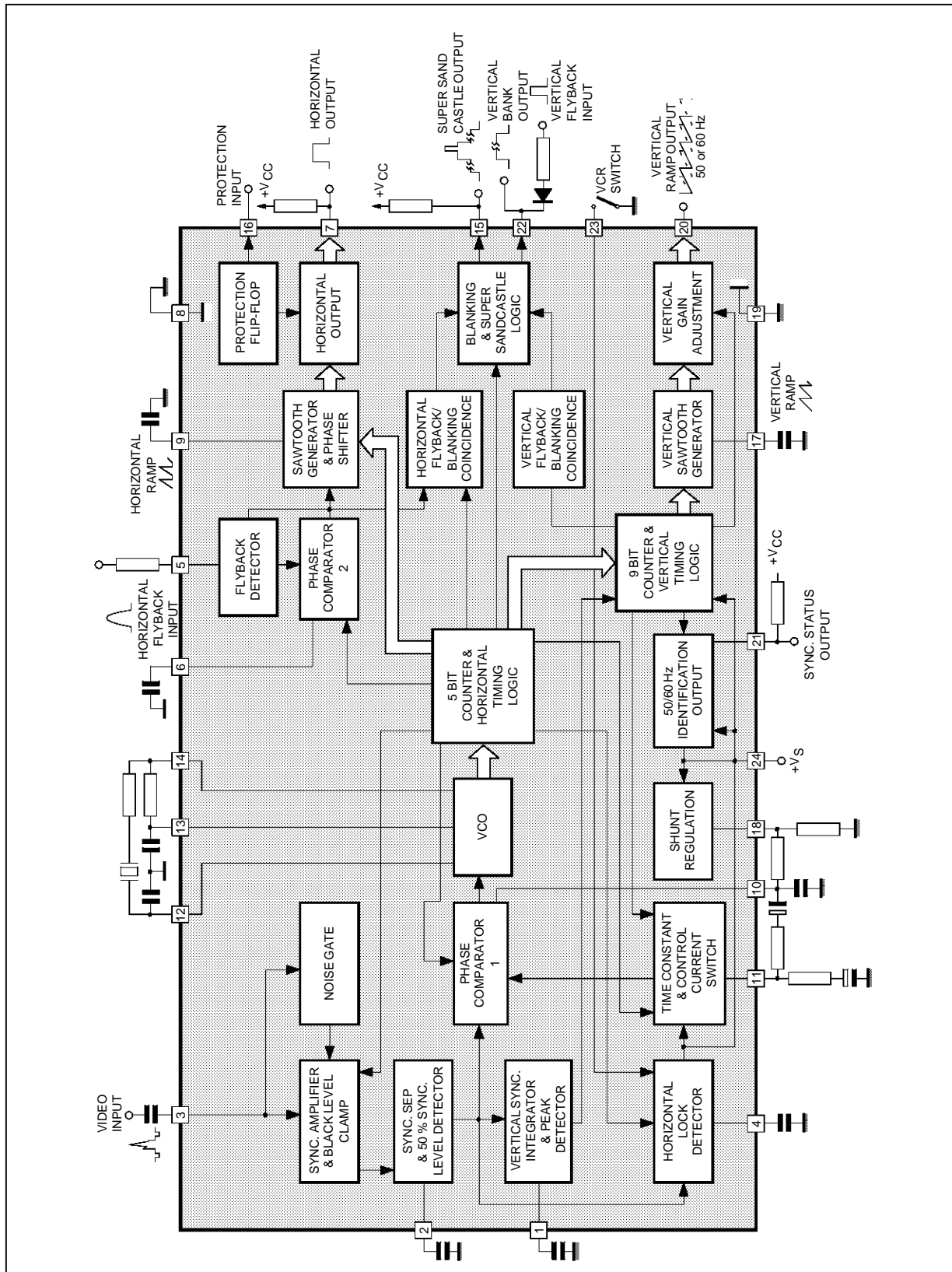

8185I-02.EPS

ABSOLUTE MAXIMUM RATINGS

Symbol	Parameter	Value	Unit
V_S	Supply Voltage at Pin 24 (low impedance)	5.25	V
V_{CC}	Voltage at Pins, 7, 15, 21	20	V
V_I	Input Signals	5	V
P_{tot}	Total Power Dissipation ($T_{amb} = 70\text{ }^\circ\text{C}$)	1	W
T_j, T_{stg}	Storage and Junction Temperature	- 40 to 150	$^\circ\text{C}$

8185I-01.TBL

THERMAL DATA

Symbol	Parameter	Value	Unit
$R_{th\ j-pins}$	Thermal Resistance Junction-pins Max	80	$^\circ\text{C}$

8185I-02.TBL

ELECTRICAL CHARACTERISTICS

($V_S = 5\text{ V}$, $V_{CC} = 12\text{ V}$, $T_{amb} = 25\text{ }^\circ\text{C}$, unless otherwise specified)

Symbol	Parameter	Test Conditions	Min.	Typ.	Max.	Unit
V_S	Supply Voltage (pin 24)		4.75	5	5.25	V
I_S	Supply Current (pin 24)		30	60	85	mA
V_{24}	Stabilized Voltage at Pin 24			5.6		V

SYNC. SEPARATOR

V_3	Peak to Peak Input Signal (negative video signal)		0.3	1	4	V
-------	---	--	-----	---	---	---

VIDEO IDENTIFICATION AND VCR SWITCH

V_{23}	VCR Switch Voltage		1.6	2.1	2.4	V
V_4	Threshold Voltage for Time Constant Switching			2.3		V
I_4	Peak Output Current	Lock		1		mA
$-I_4$	Output Current			20		μA

OSCILLATOR

F_O	Free Running Frequency			500		kHz
S_O	Frequency Control Sensitivity			1.0		kHz/V
V_{10}	Control Voltage Range			2.6 to 4		V

SYNC-OSCILLATOR PHASE COMPARATOR

I_{10}	Control Peak Current			± 0.3		mA
I_{10}	VCR Control Peak Current			± 0.6		mA
Δf	Catching and Holding Range			± 400		Hz

FLYBACK – OSCILLATOR PHASE COMPARATOR

V_6	Control Voltage Range			2.8 to 3.7		V
I_5	Flyback Input Current		0.1			
	Flyback Input Threshold			5		mA
I_6	Peak Control Current			± 0.5		mA
	Static Control Error			1		%
t_d	Permissible Delay between Output Pulse and Flyback Pulse	$t_{flyback} = 12\text{ }\mu\text{s}$		17		μs

8185I-03.TBL

TDA8185I

ELECTRICAL CHARACTERISTICS (continued)

($V_S = 5\text{ V}$, $V_{CC} = 12\text{ V}$, $T_{amb} = 25\text{ }^\circ\text{C}$, unless otherwise specified)

Symbol	Parameter	Test Conditions	Min.	Typ.	Max.	Unit
--------	-----------	-----------------	------	------	------	------

COMPOSITE BLANKING AND KEY PULSE (supersandcastle)

V_K	Key Pulse Output Peak Voltage			10		V
V_L	Line Blanking Voltage		4.25	4.5	4.75	V
V_F	Frame Blanking Voltage		2.38	2.5	2.63	V
t_{KS}	Phase Relationship between Leading Edge of Key Pulse and Middle of Sync. Pulse			2.5		μs
t_K	Key Pulse Duration			4		μs
t_F	Vertical Blanking Duration			1.4		ms

FRAME

V_{20}	Output p.p. Sawtooth Voltage	50Hz and 60Hz		2.7		V
V_{20}	Pedestal Voltage			0.3		V

LINE

I_7	Output Current			50		mA
V_7	Saturation Voltage	$I_7 = 50\text{mA}$		0.4		V
t_L	Output Pulse Duration			29		μs

SYNC. STATUS OUTPUT

V_{21}	Output Voltage	50Hz 60Hz Unlock	6.25	12 7	7.45 0.3	V V V
----------	----------------	------------------------	------	---------	-------------	-------------

OVERALL PHASE RELATION SHIP

t_o	Phase Difference between Middle of Flyback and Middle of Sync. Pulses			2		μs
-------	---	--	--	---	--	---------------

VERTICAL BLANKING OUT AND FLY. INPUT

V_{22}	Blanking Output Voltage			4		V
V_{22}	Flyback Threshold Input			5.7		V
I_{22}	Flyback Current Input		0.1			mA

- Notes :**
1. With $t_{fly} = 12\text{ } \mu\text{s}$ and $t_i = 29\text{ } \mu\text{s}$.
 2. The TDA8185I may be operated on a 5V supply directly. A 5.5 V shunt regulator is available internally for operation on higher supply voltage ; in this case an external limiting resistor is required. Without the external limiting resistor care must be taken to ensure that the supply voltage does not exceed 5.5V or the regulator will intervene and the device could be damaged.

8185I-04.TBL

Figure 1 : Horizontal and Vertical Deflections for 30AX C.R.T.

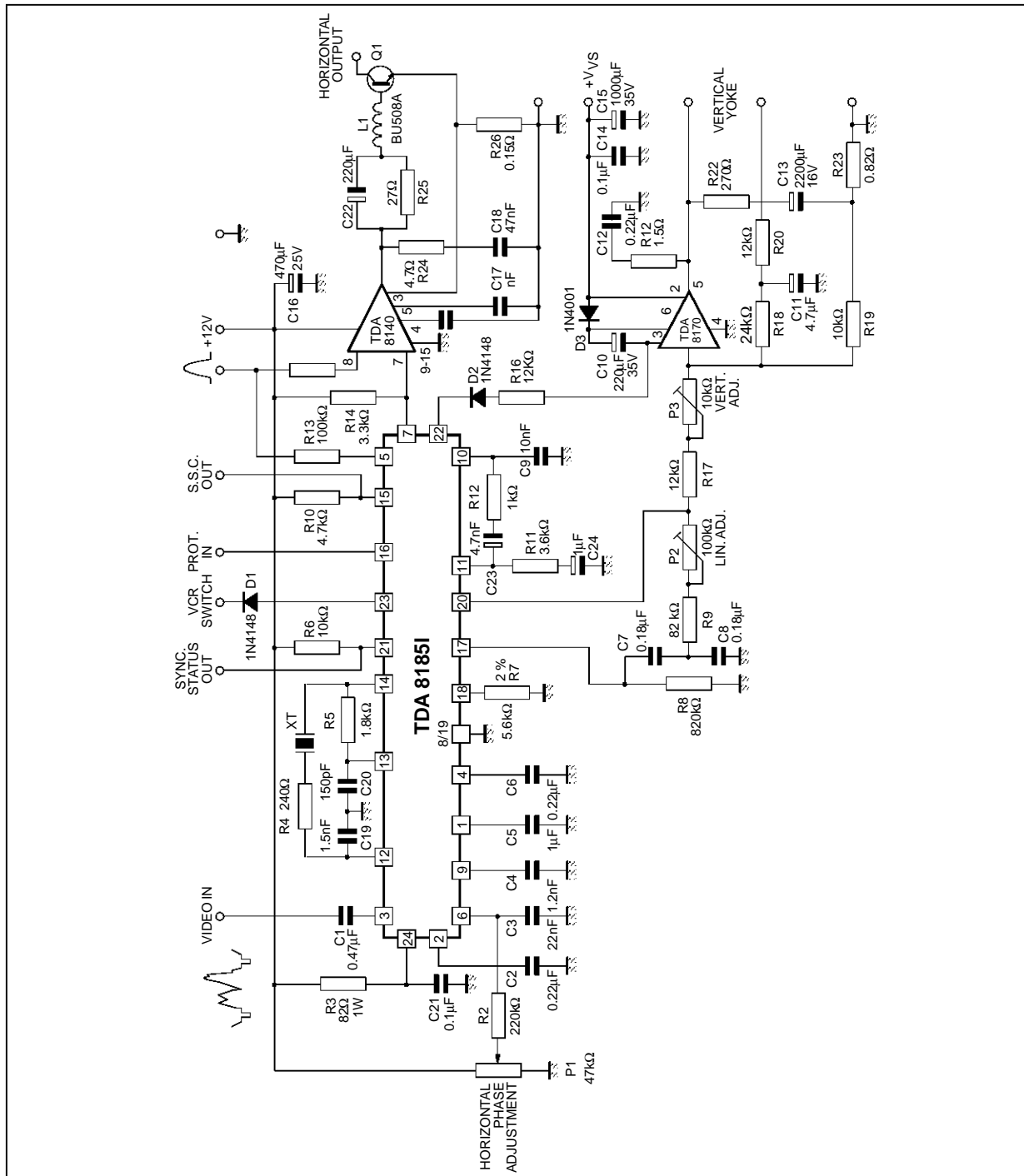

8185I-03.EPS

Figure 2 : Horizontal and Vertical Deflections for S4 C.R.T.

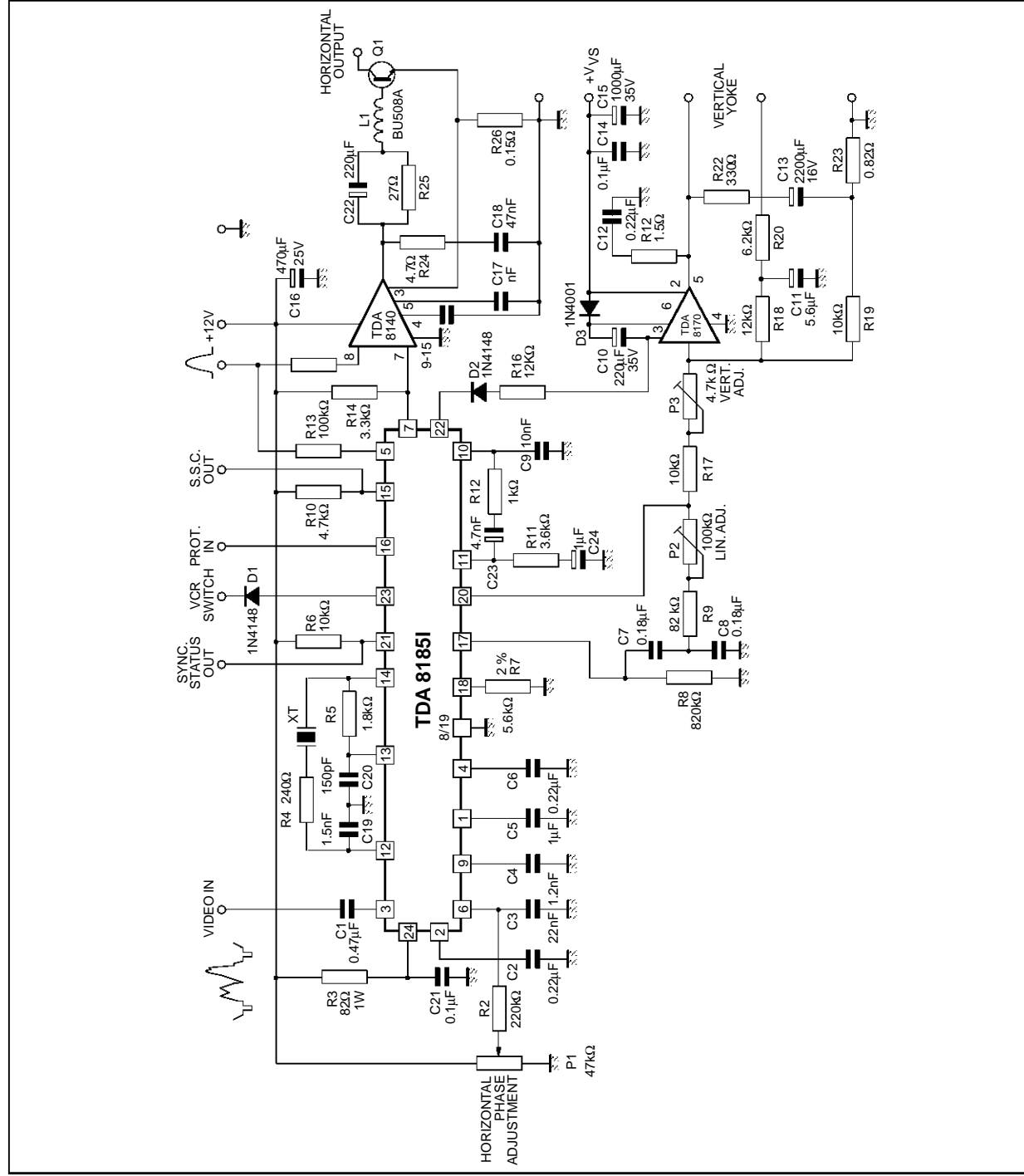

8185I-04.EPS

Figure 3 : P.C. Board and Components Layout of the Circuit of Figure 2 (1 : 1 scale)

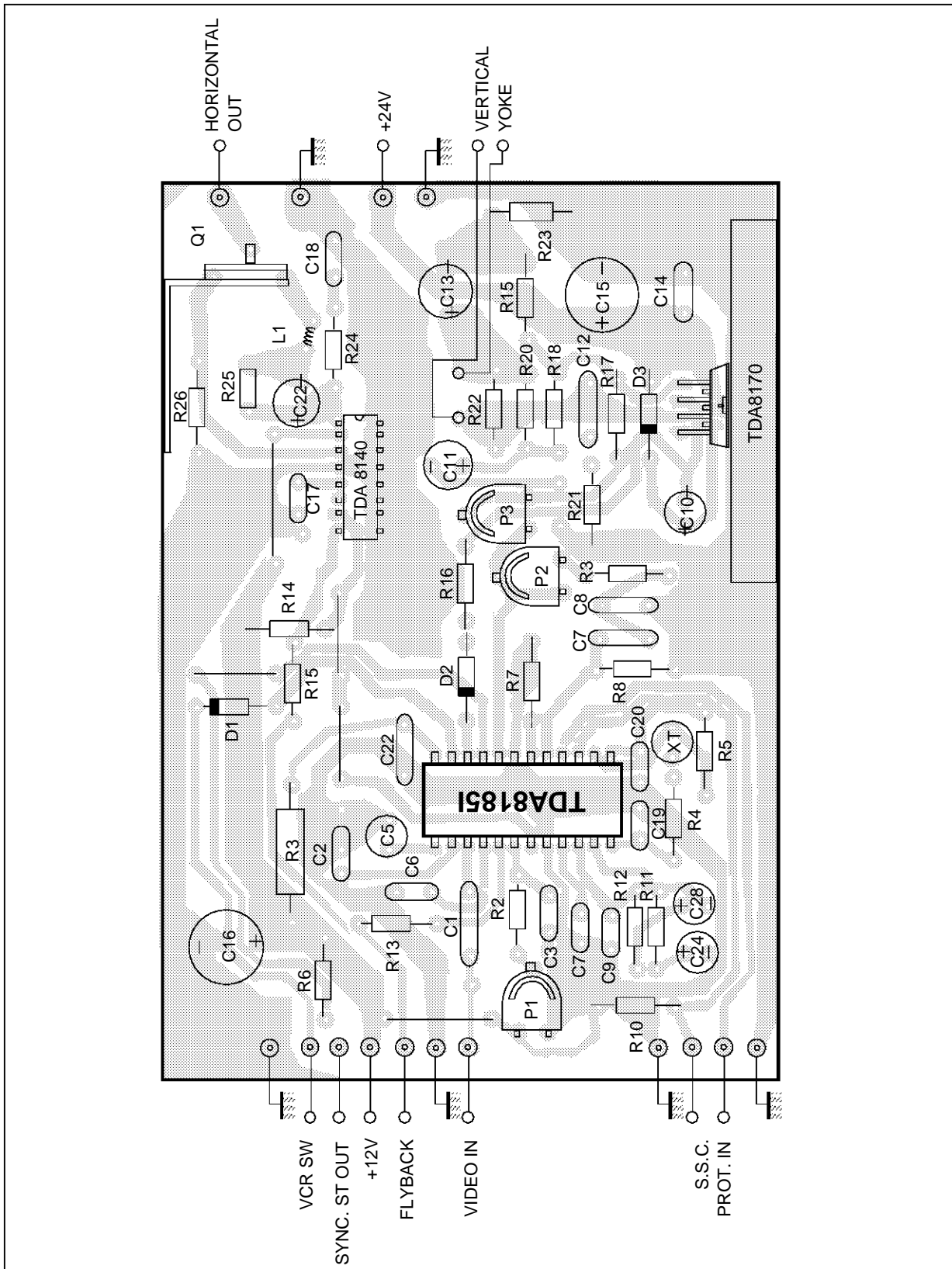

8185I-05.EPS

PACKAGE MECHANICAL DATA

24 PINS - PLASTIC DIP

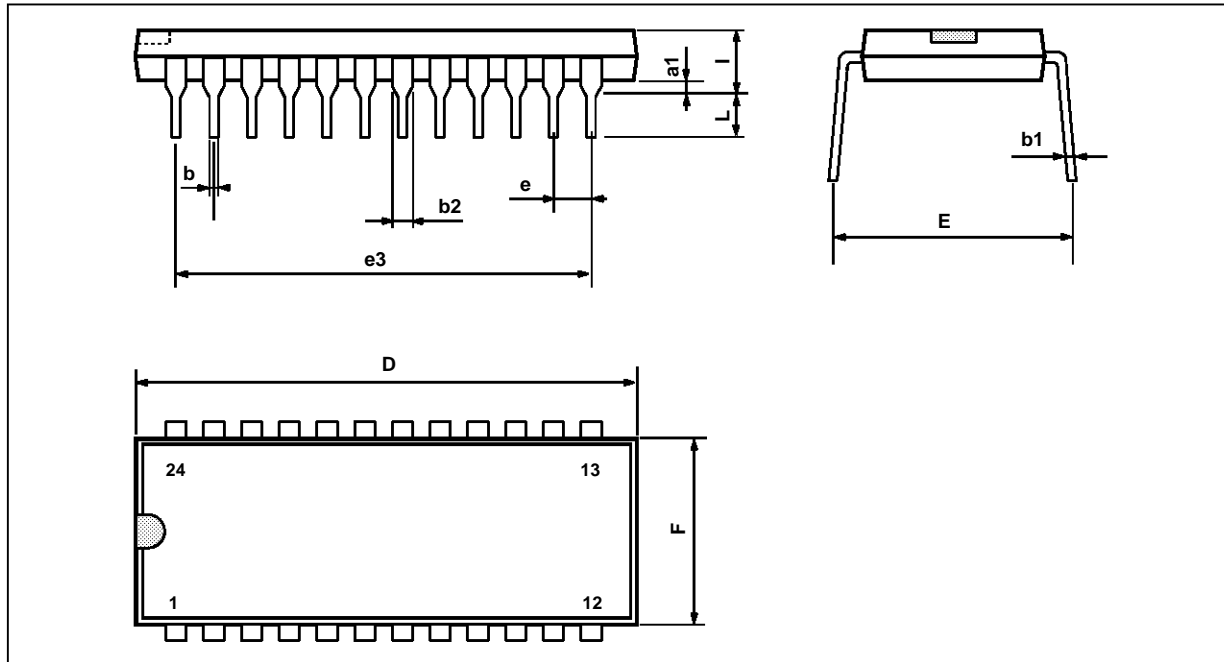

PM-DIP24.EPS

Dimensions	Millimeters			Inches		
	Min.	Typ.	Max.	Min.	Typ.	Max.
a1		0.63			0.025	
b		0.45			0.018	
b1	0.23		0.31	0.009		0.012
b2		1.27			0.050	
D			32.2			1.268
E	15.2		16.68	0.598		0.657
e		2.54			0.100	
e3		27.94			1.100	
F			14.1			0.555
i		4.445			0.175	
L		3.3			0.130	

DIP24.TBL

Information furnished is believed to be accurate and reliable. However, SGS-THOMSON Microelectronics assumes no responsibility for the consequences of use of such information nor for any infringement of patents or other rights of third parties which may result from its use. No licence is granted by implication or otherwise under any patent or patent rights of SGS-THOMSON Microelectronics. Specifications mentioned in this publication are subject to change without notice. This publication supersedes and replaces all information previously supplied. SGS-THOMSON Microelectronics products are not authorized for use as critical components in life support devices or systems without express written approval of SGS-THOMSON Microelectronics.

© 1994 SGS-THOMSON Microelectronics - All Rights Reserved

Purchase of I²C Components of SGS-THOMSON Microelectronics, conveys a license under the Philips I²C Patent. Rights to use these components in a I²C system, is granted provided that the system conforms to the I²C Standard Specifications as defined by Philips.

SGS-THOMSON Microelectronics GROUP OF COMPANIES

Australia - Brazil - China - France - Germany - Hong Kong - Italy - Japan - Korea - Malaysia - Malta - Morocco
The Netherlands - Singapore - Spain - Sweden - Switzerland - Taiwan - Thailand - United Kingdom - U.S.A.