

CD FOCUS TRACKING SERVO LSI

The TA8190F, TA8191F is a 3-beam type PUH compatible focus tracking servo LSIs to be used in the CD player system.

In combination with a CMOS single chip processor TC9236AF, a CD player system can be composed very simply.

FEATURES

- Built-in RF amp, focus error amp, and tracking error amp.
- Built-in focus tracking servo amp.
- Built-in phase compensation amp and LPF amp.
(Regarding these amp, the pin connection differs between the TA8190F and the TA8191F.)
- Built-in ALPC amp.
- Connections between PUH and power driver IC for motor driver allow simplified structuring of CD player system.

TA8190F : Directly connectable to a transistor push-pull or power driver (TA8212F).

TA8191F : Directly connectable to BTL amp (TA8192F) or PWM driver (TA8460F).

- Differences between TA8190F and TA8191F are as follows :

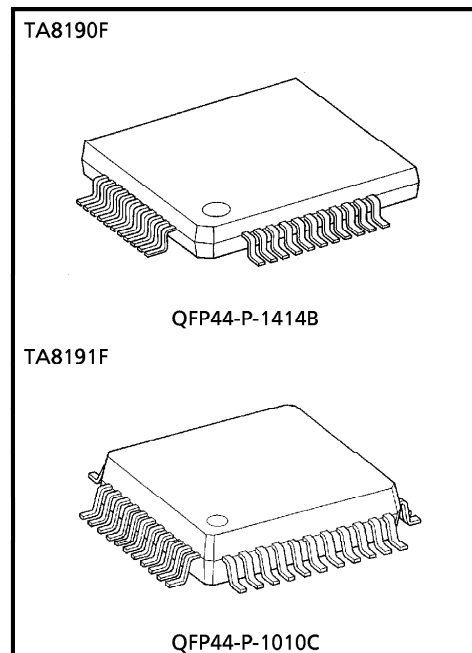

Weight QFP44-P-1414B : 1.15g (Typ.)
QFP44-P-1010C : 0.5g (Typ.)

MODEL	REFERENCE VOLTAGE TERMINAL		PACKAGE (FLAT PACKAGE 44 PIN)	POWER SUPPLY	APPLICATION
	V _{REF}	2V _{REF}			
TA8190F	Yes	No	QFP44-P-1414B	± 5V double power supply	CD player
TA8191F	Yes	Yes	QFP44-P-1010C	+ 5V single power supply	Portable CD player Radio-cassette CD player

(V_{REF} = 2.1V, 2V_{REF} = 4.2V)

© The information contained herein is presented only as a guide for the applications of our products. No responsibility is assumed by TOSHIBA CORPORATION for any infringements of intellectual property or other rights of the third parties which may result from its use. No license is granted by implication or otherwise under any intellectual property or other rights of TOSHIBA CORPORATION or others.

© These TOSHIBA products are intended for use in general commercial applications (office equipment, communication equipment, measuring equipment, domestic appliances, etc.). please make sure that you consult with us before you use these TOSHIBA products in equipment which requires extraordinarily high quality and/or reliability, and in equipment which may involve life threatening or critical application, including but not limited to such uses as atomic energy control, airplane or spaceship instrumentation, traffic signals, medical instrumentation, combustion control, all types of safety devices, etc. TOSHIBA cannot accept and hereby disclaims liability for any damage which may occur in case the TOSHIBA products are used in such equipment or applications without prior consultation with TOSHIBA.

BLOCK DIAGRAM
TA8190F

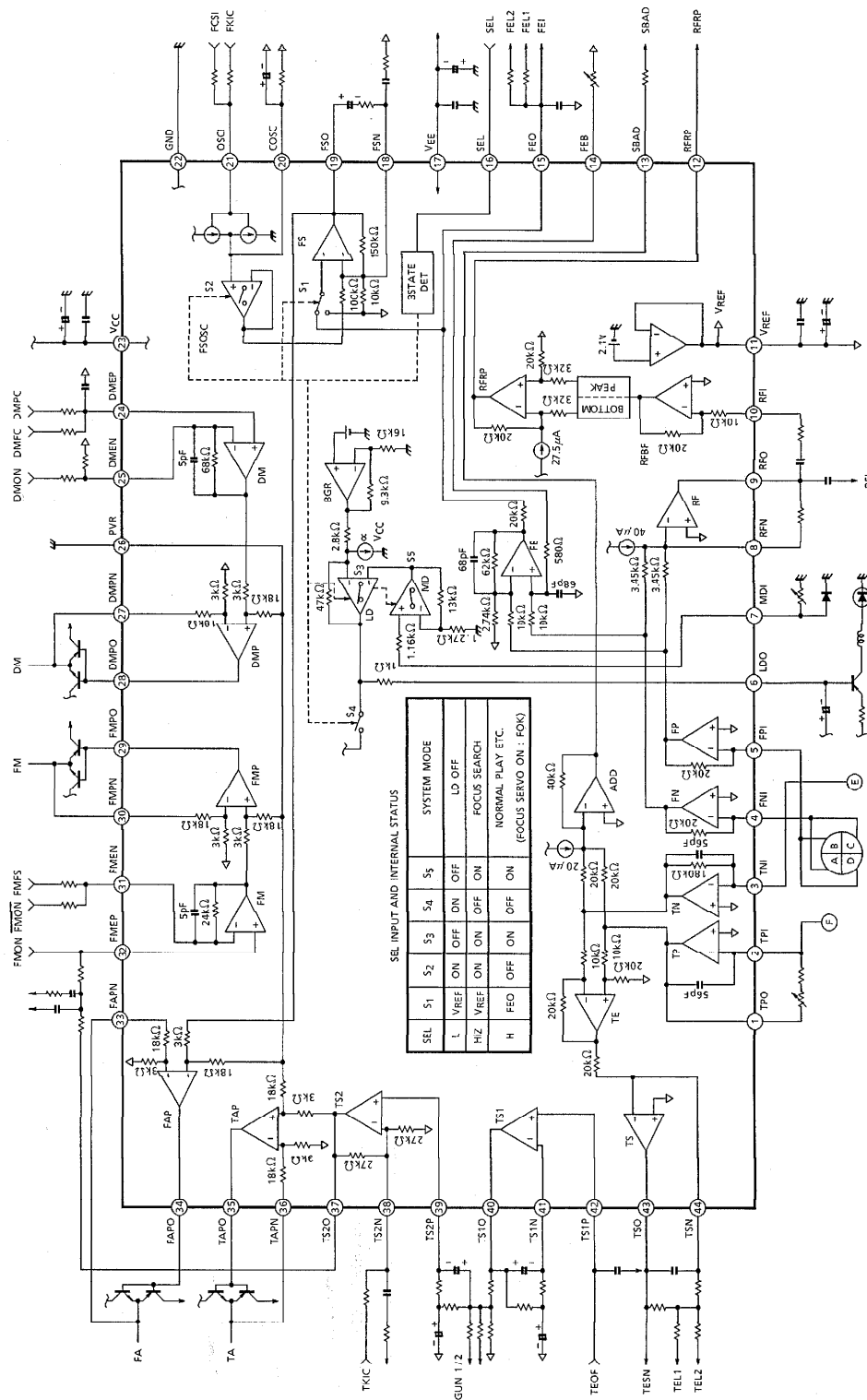

TA8190F - 2

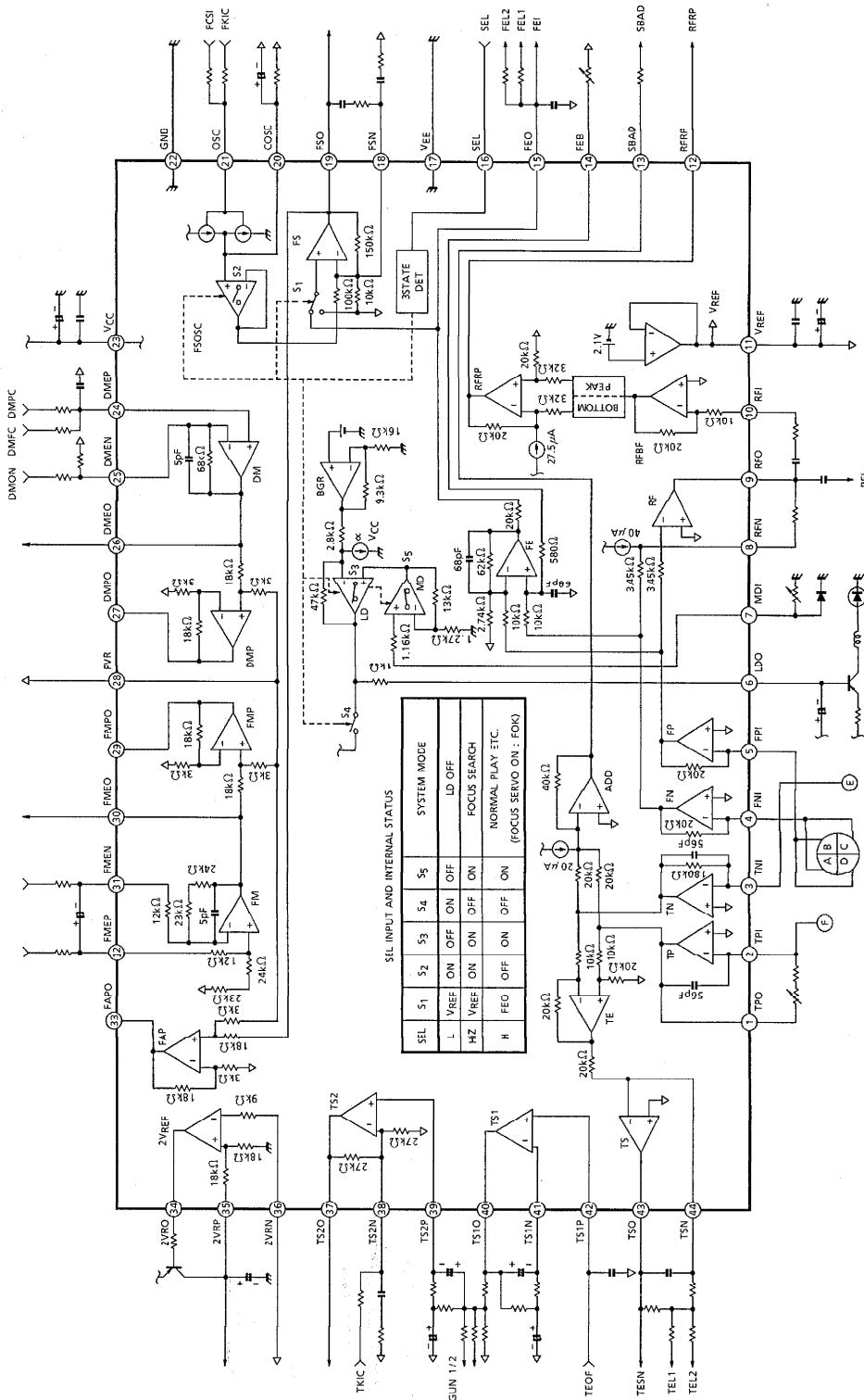

BLOCK DIAGRAM
TA8191F

TA8190F - 3

PIN FUNCTION
(Common)

PIN No.	SYMBOL	I/O	FUNCTIONAL DESCRIPTION	REMARKS
1	TPO	O	Sub-beam I-V amp (TP AMP) output terminal.	Connected to TPI through adjusting feedback resistor.
2	TPI	I	Sub-beam I-V amp (TP AMP) input terminal.	Connected to PIN diode F.
3	TNI	I	Sub-beam I-V amp (TN AMP) input terminal.	Connected to PIN diode E.
4	FNI	I	Main-beam I-V amp (FN AMP) input terminal.	Connected to PIN diode A + C.
5	FPI	I	Main-beam I-V amp (FP AMP) input terminal.	Connected to PIN diode B + D.
6	LDO	O	Laser diode amp (LD AMP) input terminal.	Connected to laser diode circuit.
7	MDI	I	Monitor photo diode amp (MD AMP) input terminal.	Connected to monitor photo diode.
8	RFN	I	RF amp (RF AMP) negative phase input terminal.	Connected to RFO through feedback resistor.
9	RFO	O	RF amp (RF AMP) output terminal.	—
10	RFI	I	RF ripple signal generating circuit input terminal.	Connected to RFO through CR.
11	VREF	O	Reference voltage supply output terminal. (+ 2.1V)	—
12	RFRP	O	RF ripple signal output terminal.	—
13	SBAD	O	Defects detection signal output terminal.	—
14	FEB	I	Focus error balance adjusting input terminal.	Adjusting semi-fixed resistor connected.
15	FEO	O	Focus error amp (FE AMP) output terminal.	Gain adjusting resistor is connected.
16	SEL	I	Analog switch control signal input terminal.	—
17	VEE	—	Power source terminal. (TA8190F : - 5V, TA8191F : GND)	—
18	FSN	I	Focus output amp (FS AMP) negative phase input terminal.	Connected to FSO through feedback CR.
19	FSO	O	Focus output amp (FS AMP) output terminal.	—
20	COSC	O	Focus search signal generating capacitor connecting terminal.	CR is connected.
21	OSCI	I	Focus search signal generating built-in current source control input terminal.	—
22	GND	—	Ground terminal.	—

(Common)

PIN No.	SYMBOL	I/O	FUNCTIONAL DESCRIPTION	REMARKS
23	V _{CC}	—	Power source terminal. (+5V)	—
24	DMEP	I	Disc motor amp (DM AMP) positive phase input terminal.	—
25	DMEN	I	Disc motor amp (DM AMP) negative phase input terminal.	—
31	FMEN	I	Feed motor amp (FM AMP) negative phase input terminal.	—
32	FMEP	I	Feed motor amp (FM AMP) positive phase input terminal.	—
37	TS2O	O	Tracking servo amp 2 (TS2 AMP) output terminal.	—
38	TS2N	I	Tracking servo amp 2 (TS2 AMP) negative phase input terminal.	—
39	TS2P	I	Tracking servo amp 2 (TS2 AMP) positive phase input terminal.	—
40	TS1O	O	Tracking servo amp 1 (TS1 AMP) output terminal.	—
41	TS1N	I	Tracking servo amp 1 (TS1 AMP) negative phase input terminal.	Connected to TS1O through feedback CR.
42	TS1P	I	Tracking servo amp 1 (TS1 AMP) positive phase input terminal.	—
43	TSO	O	Tracking output amp (TS AMP) output terminal.	—
44	TSN	I	Tracking output amp (TS AMP) negative phase input terminal.	Connected to TSO through feedback CR.

(TA8190F)

PIN No.	SYMBOL	I/O	FUNCTIONAL DESCRIPTION	REMARKS
26	PVR	I	Driving amp reference voltage input terminal.	Connect to GND.
27	DMPN	I	Disc motor driving amp (DMP AMP) negative phase input terminal.	—
28	DMPO	O	Disc motor driving amp (DMP AMP) output terminal.	Connected to DMPN through external output Tr.
29	FMPO	O	Feed motor driving amp (FMP AMP) output terminal.	Connected to EMPN through external output Tr.
30	FMPN	I	Feed motor driving amp (FMP AMP) negative phase input terminal.	—
33	FAPN	I	Focus actuator driving amp (FAP AMP) negative phase input terminal.	—
34	FAPO	O	Focus actuator driving amp (FAP AMP) output terminal.	Connected to FAPN through external output Tr.
35	TAPO	O	Tracking actuator driving amp (TAP AMP) output terminal.	Connected to TAPN through external output Tr.
36	TAPN	I	Tracking actuator driving amp (TAP AMP) negative phase input terminal.	—

(TA8191F)

PIN No.	SYMBOL	I/O	FUNCTIONAL DESCRIPTION	REMARKS
26	DMEO	O	Disc motor amp (DM AMP) output terminal.	—
27	DMPO	O	Disc motor driving amp (DM AMP) output terminal.	—
28	PVR	I	Driving amp reference voltage input terminal.	Connected to V_{REF} .
29	FMPO	O	Feed motor driving amp (FMP AMP) output terminal.	—
30	FMEO	O	Feed motor amp (FM AMP) output terminal.	—
33	FAPO	O	Focus actuator driving amp (FAP AMP) output terminal.	—
34	2VRO	O	$2V_{REF}$ amp ($2V_{REF}$ AMP) output terminal.	Connected to 2VRP through external output Tr.
35	2VRP	I	$2V_{REF}$ amp ($2V_{REF}$ AMP) positive phase input terminal.	—
36	2VRN	I	$2V_{REF}$ amp ($2V_{REF}$ AMP) negative phase input terminal.	—

MAXIMUM RATINGS (Ta = 25°C)

CHARACTERISTIC	SYMBOL	RATING	UNIT
Power Supply Voltage	V _{CC} -V _{EE}	0.3~12.0	V
Power Dissipation	TA8190F	P _D	mW
	TA8191F		
Operating Temperature	T _{opr}	-25~75	°C
Storage Temperature	T _{stg}	-55~150	°C

(*1) Derated above 25°C in the proportion of 7.7mW/°C.

(*2) Derated above 25°C in the proportion of 6.2mW/°C.

ELECTRICAL CHARACTERISTICS

(Unless otherwise specified, TA8190F : V_{CC} = 5V, V_{EE} = -5V, Ta = 25°C)
 TA8191F : V_{CC} = 5V, V_{EE} = GND, Ta = 25°C)

CHARACTERISTIC		SYMBOL	TEST CIRCUIT	TEST CONDITION	MIN.	TYP.	MAX.	UNIT
Power Source (TA8190F)	Power Supply Voltage	V _{CC}	—	Ta = -25~75°C	4.5	5.0	5.5	V
		V _{EE}	—		-5.5	-5.0	-4.5	
	Power Supply Current	I _{CC}	1	SEL = HiZ	14.0	24.0	32.0	mA
		I _{EE}	1	—	3.0	5.0	7.0	
Power Source (TA8191F)	Power Supply Voltage	V _{CC}	—	Ta = -25~75°C	4.5	5.0	5.5	V
	Power Supply Current	I _{CC}	3	—	14.0	24.0	32.0	mA
Reference Power Supply V _{REF} (Common)	Reference Voltage	V _{REF}	1, 3	—	1.95	2.10	2.25	V
	Reference Voltage Temperature Characteristic	ΔV/ΔT	1, 3	—	-3.0	-2.0	-1.0	mV/°C
	Output Current	I _{OH}	1, 3	—	5.0	—	—	mA
	Input Current	I _{OL}	1, 3	—	5.0	—	—	mA
FI ↓ RFO (Common)	Permissive Input Current	I _{IM}	1, 3	per each ch	30	—	—	μA
	Transfer Resistance	R _T	1, 3	f = 100kHz	115	127	140	kΩ
	Frequency Characteristic	f _c	2, 4	-3dB point	3.0	—	—	MHz
	Output Signal Slew Rate	SR	2, 4	C _{RFO} = 20pF	10	20	—	V/μs
	Total Harmonic Distortion	THD	1, 3	f = 100kHz V _{REO} = 1.27V _{p-p}	—	-40	-30	dB

CHARACTERISTIC		SYMBOL	TEST CIR-CUIT	TEST CONDITION	MIN.	TYP.	MAX.	UNIT
FI ↓ RFO (Common)	Operation Reference Voltage	V _{OPR}	1, 3	V _{REF} reference	-1.13	-0.88	-0.72	V
	Upper Limit Output Voltage	V _{OH}	1, 3	V _{REF} reference	1.4	—	—	V
	Lower Limit Output Voltage	V _{OL}	1, 3	V _{REF} reference	—	—	-1.4	V
	Permissive Load Resistance	R _{LM}	—	—	10	—	—	kΩ
RFI ↓ RFRP (Common)	Input Operating Voltage	V _I	1, 3	—	0.8	—	1.6	V _{p-p}
	Voltage Gain	G _V	1, 3	f = 1kHz	0.55	0.62	0.69	V/V
	Peak Hold Frequency Characteristic	f _{CPD}	1, 3	—	60	120	240	kHz
	Bottom Hold Frequency Characteristics	f _{CBD}	1, 3	—	60	120	240	kHz
	Operation Reference Voltage 1	V _{OPR}	1, 3	V _{REF} reference	-0.61	-0.55	-0.49	V
	Operation Reference Voltage 2	V _{OPR}	1, 3	V _{REF} reference 700kHz, 1V _{p-p} input	-120	0	120	mV
	Permissive Load Resistance	R _{LM}	—	—	10	—	—	kΩ
FI ↓ FEO (Common)	Transfer Resistance	R _T	1, 3	f = 1kHz	97	124	151	kΩ
	Gain Balance	GB	1, 3	f = 1kHz	-1.5	—	1.5	dB
	Frequency Characteristic	f _c	1, 3	-3dB point	20	30	60	kHz
	Total Harmonic Distortion	THD	1, 3	f = 1kHz V _{FEO} = 1.7V _{p-p}	—	—	-40	dB
	Output Offset Voltage	V _{OS}	1, 3	V _{REF} reference	-100	—	100	mV
	Offset Voltage Drift	ΔV/ΔT	1, 3	—	-400	—	400	μV/°C
	Upper Limit Output Voltage	V _{OH}	1, 3	V _{REF} reference	1.5	—	—	V
	Lower Limit Output Voltage	V _{OL}	1, 3	V _{REF} reference	—	—	-1.5	V

CHARACTERISTIC		SYMBOL	TEST CIR-CUIT	TEST CONDITION	MIN.	TYP.	MAX.	UNIT
TI ↓ TSO (Common)	Permissive Input Current	I_{IM}	1, 3	Per each ch	5.0	—	—	μA
	Transfer Resistance	R_T	1, 3	$f = 1\text{kHz}$	354	432	554	$k\Omega$
	Gain Balance	GB	1, 3	$f = 1\text{kHz}$	-2.0	—	2.0	dB
	Frequency Characteristic	f_c	1, 3	-3dB point	10	16	30	kHz
	Total Harmonic Distortion	THD	1, 3	$f = 1\text{kHz}$ $V_{TSO} = 0.8V_{p-p}$	—	—	-40	dB
	Output Offset Voltage	V_{OS}	1, 3	V_{REF} reference	-50	—	50	mV
	Offset Voltage Drift	$\Delta V / \Delta T$	1, 3	—	-200	—	200	$\mu V / ^\circ C$
	Upper Limit Output Voltage	V_{OH}	1, 3	V_{REF} reference	1.5	—	—	V
	Lower Limit Output Voltage	V_{OL}	1, 3	V_{REF} reference	—	—	-1.5	V
Permissive Load Resistance	R_{LM}	—	—	10	—	—	$k\Omega$	
TI ↓ SBAD (Common)	Permissive Input Current	I_{IM}	1, 3	Total in both ch	7.0	—	—	μA
	Transfer Resistance	R_T	1, 3	$f = 1\text{kHz}$	280	360	440	$k\Omega$
	Frequency Characteristic	f_c	1, 3	-3dB point	10	16	30	kHz
	Total Harmonic Distortion	THD	1, 3	$f = 1\text{kHz}$ $V_{SBAD} = 1.6V_{p-p}$	—	—	-40	dB
	Operation Reference Voltage	V_{OPR}	1, 3	V_{REF} reference	-0.88	-0.80	-0.72	V
	Upper Limit Output Voltage	V_{OH}	1, 3	V_{REF} reference	1.5	—	—	V
	Lower Limit Output Voltage	V_{OL}	1, 3	V_{REF} reference	—	—	-1.5	V
	Permissive Load Resistance	R_{LM}	—	—	10	—	—	$k\Omega$
OSCI ↓ FSO (Common)	Output Amplitude	V_O	—	$f_{OSCI} = 0.5\text{Hz}$ (CMOS level)	610	700	780	mV_{p-p}
	Output Offset Voltage	V_{OS}	—	OSCI : HiZ	-35	—	35	mV
	Output Switch Isolation	V_{ISO}	—	$f_{OSCI} = 0.5\text{Hz}$ SEL : "H" level	—	—	25	mV_{p-p}

CHARACTERISTIC		SYMBOL	TEST CIR-CUIT	TEST CONDITION	MIN.	TYP.	MAX.	UNIT
FEO ↓ FSO (TA8190F)	Voltage Gain 1	G_{V1}	—	$f = 10\text{kHz}$ $V_{FSO} = 1V_{p-p}$	14.5	16.0	17.5	V/V
	Voltage Gain 2	G_{V2}	—	$R_{NF} \text{ (FSO-FSN)} : 12k\Omega$	1.79	2.11	2.43	V/V
	Upper Limit Output Voltage	V_{OH}	—	GND reference	3.6	—	—	V
	Lower Limit Output Voltage	V_{OL}	—	GND reference	—	—	0.5	V
	Output Offset Voltage	V_{OS}	—	—	-32	—	32	mV
	Total Harmonic Distortion	THD	—	$f = 10\text{kHz}$ $V_{FSO} = 1V_{p-p}$	—	—	-40	dB
FEO ↓ FSO (TA8191F)	Voltage Gain 1	G_{V1}	—	$f = 10\text{kHz}$ $V_{FSO} = 1V_{p-p}$	14.5	16.0	17.5	V/V
	Voltage Gain 2	G_{V2}	—	$R_{NF} \text{ (FSO-FSN)} : 12k\Omega$	1.79	2.11	2.43	V/V
	Upper Limit Output Voltage	V_{OH}	—	GND reference	3.6	—	—	V
	Lower Limit Output Voltage	V_{OL}	—	GND reference	—	—	0.5	V
	Output Offset Voltage	V_{OS}	—	—	-32	—	32	mV
	Total Harmonic Distortion	THD	—	$f = 10\text{kHz}$ $V_{FSO} = 1V_{p-p}$	—	—	-40	dB
FEO ↓ FAPO (TA8190F)	Voltage Gain	G_V	—	$f = 10\text{kHz}$ $V_{FAPO} = 1V_{p-p}$	80	96	114	V/V
	Upper Limit Output Voltage	V_{OH}	—	GND reference	2.8	—	—	V
	Lower Limit Output Voltage	V_{OL}	—	GND reference	—	—	-2.8	V
	Output Offset Voltage	V_{OS}	—	—	-200	—	200	mV
	Total Harmonic Distortion	THD	—	$f = 10\text{kHz}$ $V_{FAPO} = 1V_{p-p}$ $R_L = 8\Omega$	—	—	-40	dB

CHARACTERISTIC		SYMBOL	TEST CIR-CUIT	TEST CONDITION	MIN.	TYP.	MAX.	UNIT
FEO ↓ FAPO (TA8191F)	Voltage Gain	G_V	—	$f = 10\text{kHz}$ $V_{FAPO} = 1V_{p-p}$	14.0	16.0	18.0	V/V
	Upper Limit Output Voltage	V_{OH}	—	GND reference	3.6	—	—	V
	Lower Limit Output Voltage	V_{OL}	—	GND reference	—	—	1.0	V
	Output Offset Voltage	V_{OS}	—	—	-40	—	40	mV
	Total Harmonic Distortion	THD	—	$f = 10\text{kHz}$ $V_{FAPO} = 1V_{p-p}$	—	—	-40	dB
TS1P ↓ TS1O (Common)	Voltage Gain	G_V	—	$f = 10\text{kHz}$ $V_{TS1O} = 1V_{p-p}$	0.95	1.00	1.05	V/V
	Upper Limit Output Voltage	V_{OH}	—	GND reference	3.6	—	—	V
	Lower Limit Output Voltage	V_{OL}	—	GND reference	—	—	1.0	V
	Output Offset Voltage	V_{OS}	—	—	-5.0	—	5.0	mV
	Input Bias Current	I_I	—	—	-100	—	100	nA
	Total Harmonic Distortion	THD	—	$f = 10\text{kHz}$ $V_{TS1O} = 1V_{p-p}$	—	—	-40	dB
TS2P ↓ TS2O (Common)	Voltage Gain	G_V	—	$f = 10\text{kHz}$ $V_{TS2O} = 1V_{p-p}$	1.9	2.0	2.1	V/V
	Upper Limit Output Voltage	V_{OH}	—	GND reference	3.6	—	—	V
	Lower Limit Output Voltage	V_{OL}	—	GND reference	—	—	0.5	V
	Output Offset Voltage	V_{OS}	—	—	-10	—	10	mV
	Input Bias Current	I_I	—	—	-100	—	100	nA
	Total Harmonic Distortion	THD	—	$f = 10\text{kHz}$ $V_{TS2O} = 1V_{p-p}$	—	—	-40	dB

CHARACTERISTIC		SYMBOL	TEST CIRCUIT	TEST CONDITION	MIN.	TYP.	MAX.	UNIT
TS2P ↓ TAPO (TA8190F)	Voltage Gain	G_V	—	$f = 10\text{kHz}$ $V_{TAPO} = 1V_{p-p}$	10.5	12.0	13.5	V/V
	Upper Limit Output Voltage	V_{OH}	—	GND reference	2.8	—	—	V
	Lower Limit Output Voltage	V_{OL}	—	GND reference	—	—	-2.8	V
	Output Offset Voltage	V_{OS}	—	—	-80	—	80	mV
	Total Harmonic Distortion	THD	—	$f = 10\text{kHz}$ $V_{TAPO} = 1V_{p-p}$ $R_L = 8\Omega$	—	—	-40	dB
DMEP ↓ DMEO (TA8191F)	Voltage Gain	G_V	—	$f = 10\text{kHz}$ $V_{DMEO} = 1V_{p-p}$	5.7	6.7	7.7	V/V
	Upper Limit Output Voltage	V_{OH}	—	GND reference	3.6	—	—	V
	Lower Limit Output Voltage	V_{OL}	—	GND reference	—	—	0.5	V
	Output Offset Voltage	V_{OS}	—	—	-15	—	15	mV
	Total Harmonic Distortion	THD	—	$f = 10\text{kHz}$ $V_{DMEO} = 1V_{p-p}$	—	—	-40	dB
DMEP ↓ DMPO (TA8190F)	Voltage Gain	G_V	—	$f = 10\text{kHz}$ $V_{DMPO} = 1V_{p-p}$	32	40	50	V/V
	Upper Limit Output Voltage	V_{OH}	—	GND reference	2.8	—	—	V
	Lower Limit Output Voltage	V_{OL}	—	GND reference	—	—	-2.8	V
	Output Offset Voltage	V_{OS}	—	—	-100	—	100	mV
	Total Harmonic Distortion	THD	—	$f = 10\text{kHz}$ $V_{DMPO} = 1V_{p-p}$ $R_L = 8\Omega$	—	—	-35	dB

CHARACTERISTIC		SYMBOL	TEST CIR-CUIT	TEST CONDITION	MIN.	TYP.	MAX.	UNIT
DMEP ↓ DMPO (TA8191F)	Voltage Gain	G_V	—	$f = 10\text{kHz}$ $V_{DMPO} = 1V_{p-p}$	5.4	6.7	8.0	V/V
	Upper Limit Output Voltage	V_{OH}	—	GND reference	3.6	—	—	V
	Lower Limit Output Voltage	V_{OL}	—	GND reference	—	—	1.2	V
	Output Offset Voltage	V_{OS}	—	—	-30	—	30	mV
	Total Harmonic Distortion	THD	—	$f = 10\text{kHz}$ $V_{DMPO} = 1V_{p-p}$	—	—	-40	dB
FMEP ↓ FMEO (TA8191F)	Voltage Gain	G_V	—	$f = 10\text{kHz}$ $V_{FMEO} = 1V_{p-p}$ $V_{FMEN} = V_{REF}$	3.6	3.9	4.3	V/V
	Upper Limit Output Voltage	V_{OH}	—	GND reference	3.6	—	—	V
	Lower Limit Output Voltage	V_{OL}	—	GND reference	—	—	0.5	V
	Output Offset Voltage	V_{OS}	—	—	-15	—	15	mV
	Total Harmonic Distortion	THD	—	$f = 10\text{kHz}$ $V_{FMEO} = 1V_{p-p}$	—	—	-40	dB
FMEP ↓ FMPO (TA8190F)	Voltage Gain	G_V	—	$f = 10\text{kHz}$ $V_{FMPO} = 1V_{p-p}$	124	150	177	V/V
	Upper Limit Output Voltage	V_{OH}	—	GND reference	2.8	—	—	V
	Lower Limit Output Voltage	V_{OL}	—	GND reference	—	—	-2.8	V
	Output Offset Voltage	V_{OS}	—	—	-500	—	500	mV
	Total Harmonic Distortion	THD	—	$f = 10\text{kHz}$ $V_{FMPO} = 1V_{p-p}$ $R_L = 8\Omega$	—	—	-30	dB

CHARACTERISTIC		SYMBOL	TEST CIR-CUIT	TEST CONDITION	MIN.	TYP.	MAX.	UNIT
FMPEP ↓ FMPO (TA8191F)	Voltage Gain	G_V	—	$f = 10\text{kHz}$ $V_{FMPO} = 1V_{p-p}$ $V_{FMEN} = V_{REF}$	3.4	3.9	4.6	V/V
	Upper Limit Output Voltage	V_{OH}	—	GND reference	3.6	—	—	V
	Lower Limit Output Voltage	V_{OL}	—	GND reference	—	—	1.0	V
	Output Offset Voltage	V_{OS}	—	—	-20	—	20	mV
	Total Harmonic Distortion	THD	—	$f = 10\text{kHz}$ $V_{FMPO} = 1V_{p-p}$	—	—	-40	dB
2VRN ↓ 2VR (TA8191F)	DC Voltage Gain	G_{VDC}	—	$V_{2VR} = V_{REF}$	1.90	2.00	2.10	V/V
MDI ↓ LDO (Common)	Reference Operating Voltage	V_{MDI}	—	V_{MDI} at which V_{LDO} becomes 3.5V.	170	178	192	mV
	Voltage Gain	G_V	—	$f = 10\text{kHz}$ $V_{LDO} = 0.5V_{p-p}$	170	200	230	mV
	Input Bias Current	I_I	—	—	-200	—	200	nA
	Ripple Removing Ratio (With V_{CC})	RR	—	Input converted value	—	—	-56	dB
	Frequency Characteristic	f_c	—	-3dB point	20	—	—	kHz
	LD Off Voltage (With V_{CC})	$V_{LD\ OFF}$	—	SEL = L	-0.7	—	—	V

TEST CIRCUIT 2

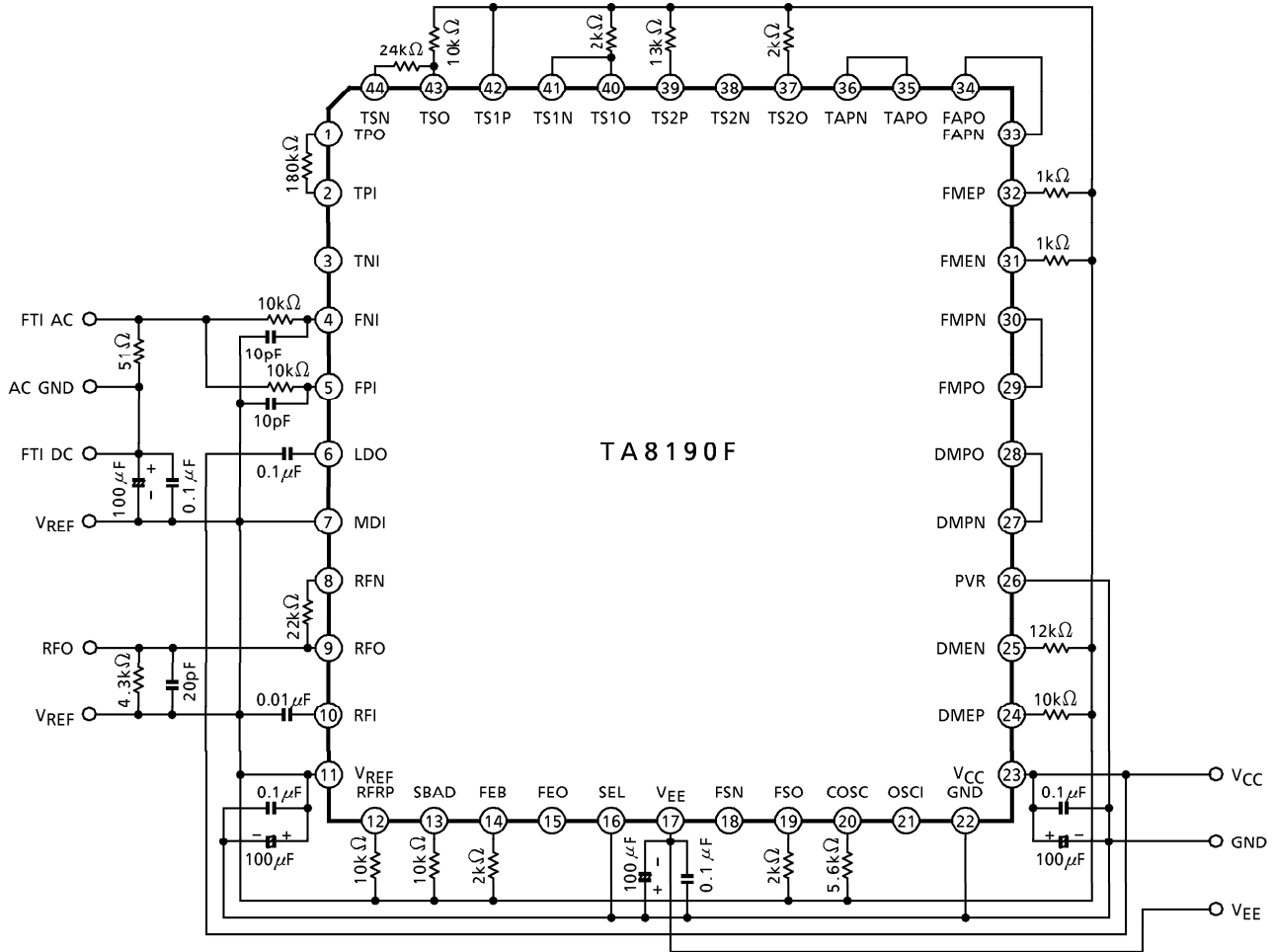

TEST CIRCUIT 3

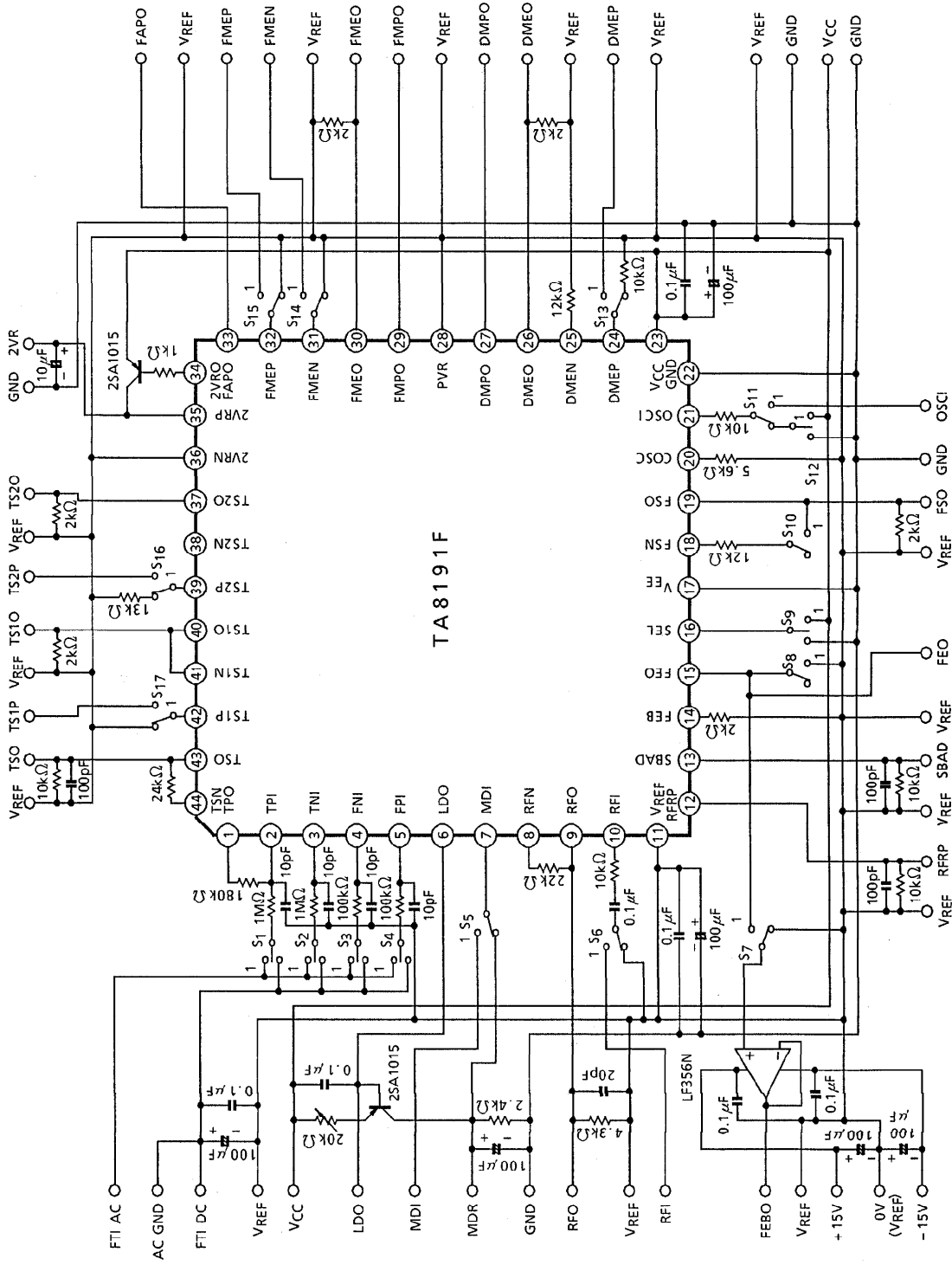

TA8190F - 17

TEST CIRCUIT 4

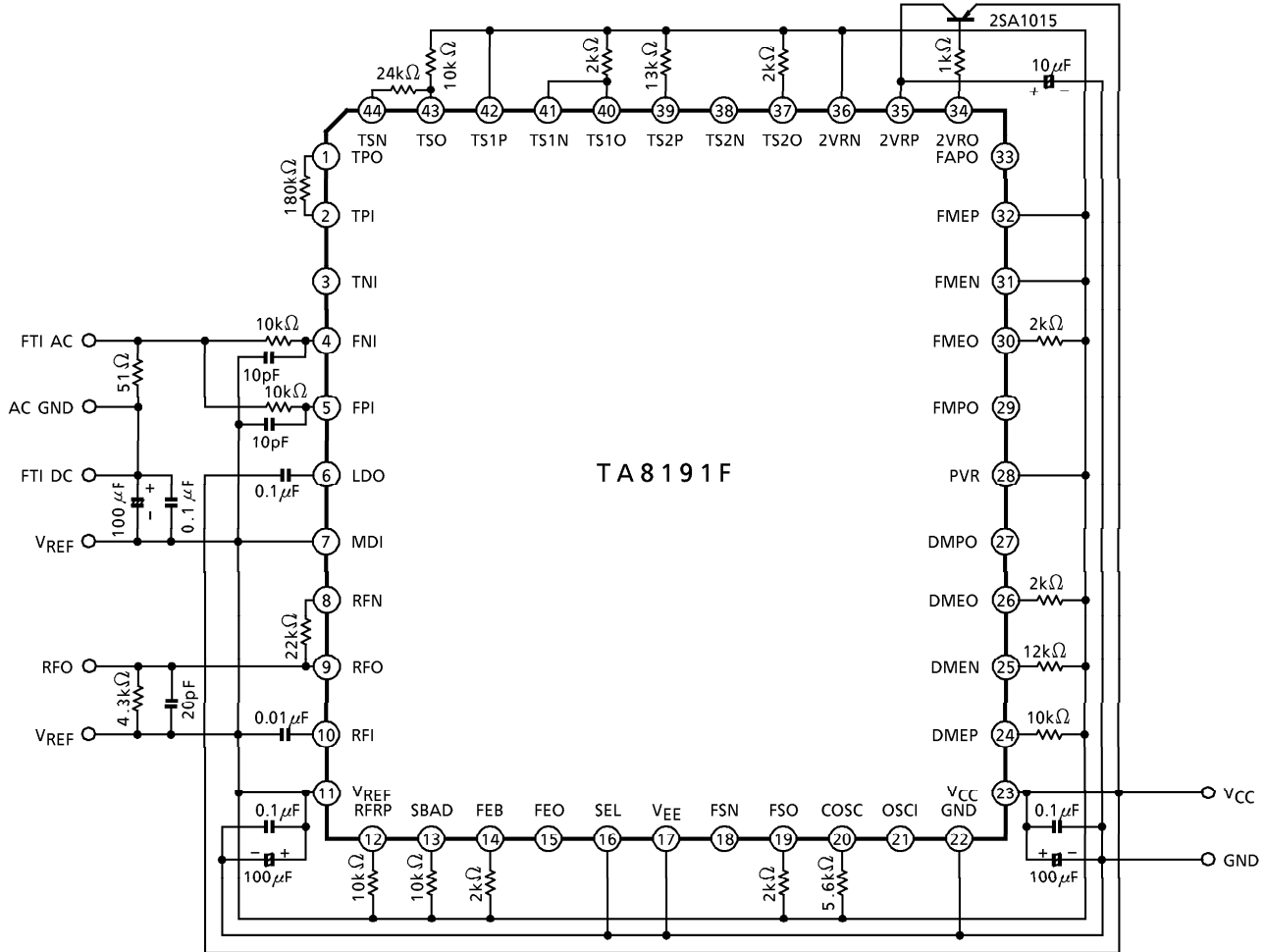

OUTLINE DRAWING
QFP44-P-1414B

Unit : mm

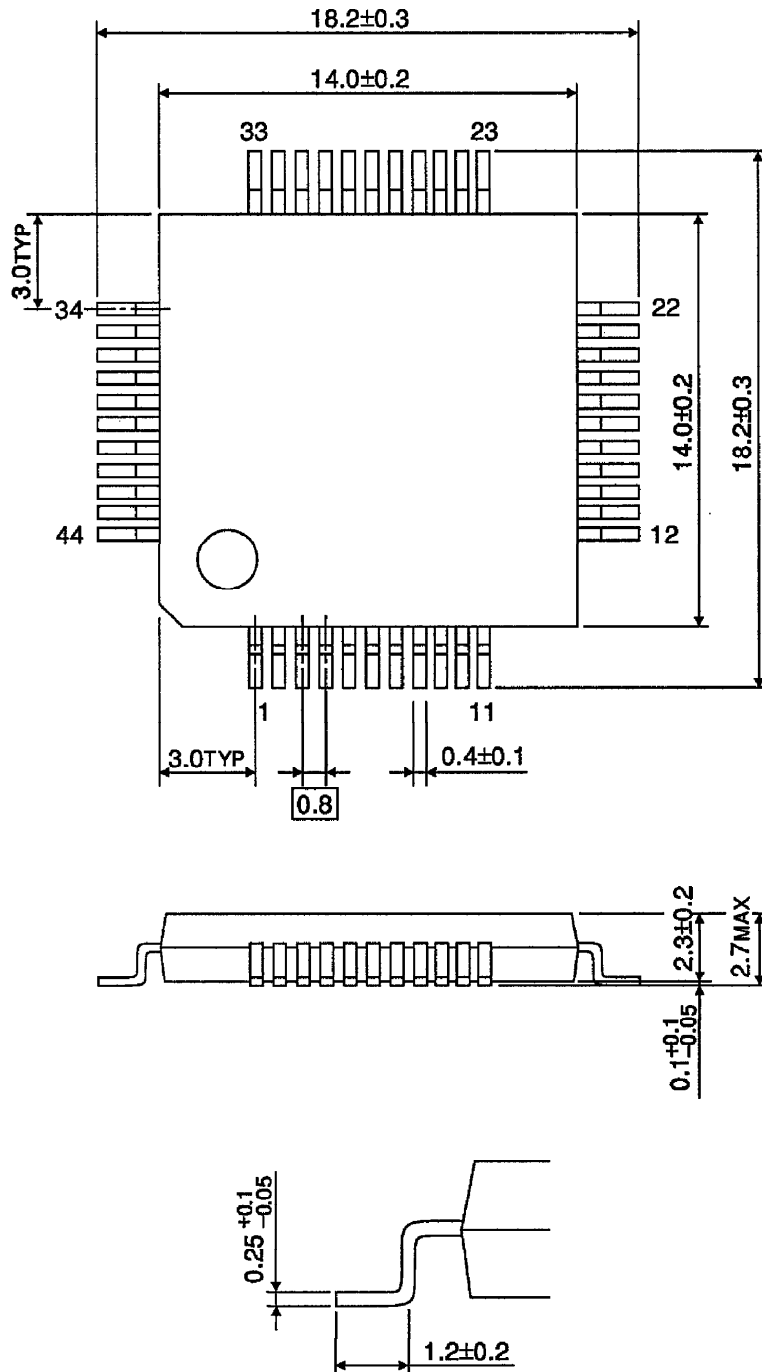

Weight : 1.15g (Typ.)

OUTLINE DRAWING
 QFP44-P-1010C

Unit : mm

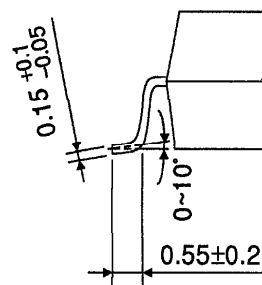
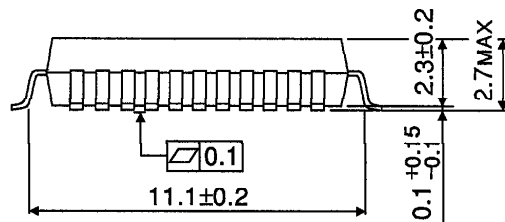
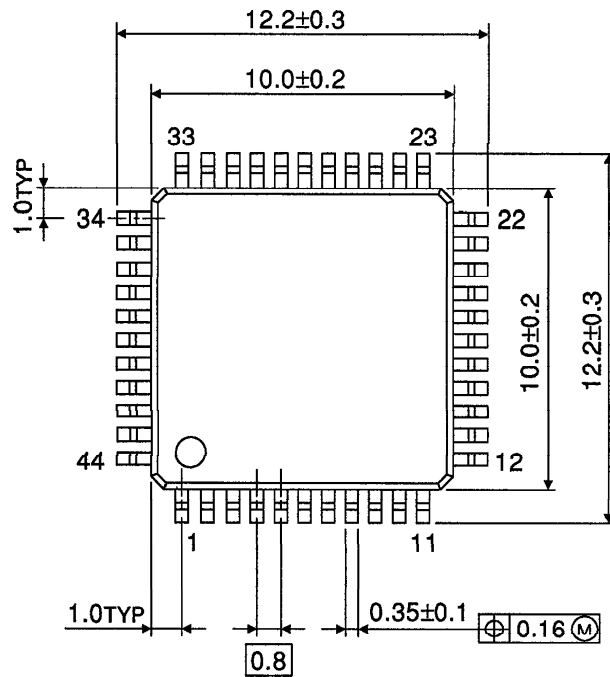

Weight : 0.5g (Typ.)

TA8190F - 20*
1995 - 5 - 29
TOSHIBA CORPORATION