

**SANYO**

No.3313C

**LA7837, 7838****Vertical Deflection Circuit  
with TV / CRT Display Drive****Overview**

The LA7837,7838 are vertical deflection output ICs developed for use in high-grade TVs and displays. The interlace and crossover distortion responses, in particular, have been greatly improved, allowing excellent picture quality on large size televisions and high precision interlace mode displays.

Also, pulse signals can be used for input signals due to the on-chip sawtooth wave generating circuit and driver circuit. Further, the DC and AC feedback circuits can be formed with these ICs alone, simplifying pattern design of sets and ensuring stable performance. All of the functions in a color TV signal system can be processed by connecting these ICs with Sanyo's single-chip IC LA7670 series (NTSC) and LA7680/85 series (PAL/NTSC) (VIF/SIF, video, chroma, deflection).

The LA7837 has maximum deflection current of 1.8Ap-p, making it appropriate for use in portable to mid-size televisions.

The LA7838 has a maximum deflection current of 2.2Ap-p, so it can be used for large size sets, and can drive from 33 to 37 inches.

**Features**

- Low power dissipation due to on-chip pump-up circuit
- On-chip 50/60Hz vertical size control circuit
- On-chip sawtooth wave generating circuit
- On-chip drive circuit
- Vertical output circuit
- On-chip thermal protection circuit
- Excellent interlace response
- Excellent crossover response

**Maximum Ratings at Ta = 25°C**

			unit
Driver Supply Voltage	+ VCC1 max	15	V
Pump-up Supply Voltage	+ VCC8 max	30	V
Output Supply Voltage	+ VCC13 max	62	V
Deflection Output Current	I <sub>DEF</sub>	-1.5 to +1.5	Ap-o
Thermal Resistance	θ <sub>j-c</sub>	4	°C/W
Allowable Power Dissipation	P <sub>d</sub> max With infinite heat sink	8	W
Operating Temperature	T <sub>opr</sub>	-20 to +85	°C
Storage Temperature	T <sub>stg</sub>	-40 to +150	°C

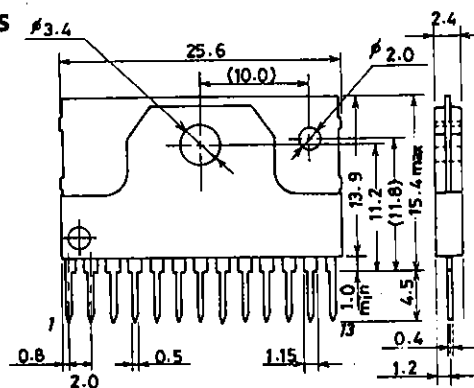
**Package Dimensions**(unit : mm)  
3107

SANYO : SIP13H

**SANYO Electric Co., Ltd. Semiconductor Business Headquarters**

TOKYO OFFICE Tokyo Bldg., 1-10, 1 Chome, Ueno, Taito-ku, TOKYO, 110 JAPAN

71693TS /8251TS(KOTO) /2090TA, TS(AF) No.3313-1/9

## LA7837, 7838

Operating Conditions at  $T_a = 25^\circ\text{C}$ , parenthesis indicates LA7838.

Parameter	Symbol	Value	Unit
Recommended Driver Supply Voltage	$+V_{CC1}$	12	V
Operating Driver Supply Voltage	$+V_{CC1}$	8 to 14	V
Recommended Pump-up Supply Voltage	$+V_{CC8}$	24	V
Operating Pump-up Supply Voltage	$+V_{CC8}$	10 to 27	V
Deflection Output Current	I12p-p	up to 1.8 (2.2)	Ap-p
Operating Ramp Waveform Pulse Height	V6p-p	up to $\{( + B1/3) - 1.0\}$	Vp-p

Operating Characteristics at  $T_a = 25^\circ\text{C}$ ,  $+V_{CC1} = 12\text{V}$ ,  $+V_{CC8} = 24\text{V}$ , parenthesis ( ) indicate LA7838.

Parameter	Symbol	min	typ	max	unit
Driver Supply Current	$I_{CC1}$	5.6	6.7	7.8	mA
Trigger Input Threshold Voltage	V2	2.6	2.9	3.2	V
Vertical Amplitude	V4	5.9	6.1	6.3	V
Control Pin Voltage					
Ramp Waveform Generation	$V_{RAMP}$	4.6	4.9	5.2	V
Start Voltage					
Pump-up Charge	$V_{s9-11}$			1.8	V
Saturation Voltage					
Pump-up Discharge	$V_{s8-9}$			3.0	V
Saturation Voltage				(3.2)	V
Deflection Output	$V_{s12-11}$			1.2	V
Saturation Voltage (Lower)				(1.5)	V
Deflection Output	$V_{s13-12}$			3.2	V
Saturation Voltage (Upper)				(3.5)	V
Idling Current	$I_{DL}$	35		65	mA
Voltage Gain			59		dB

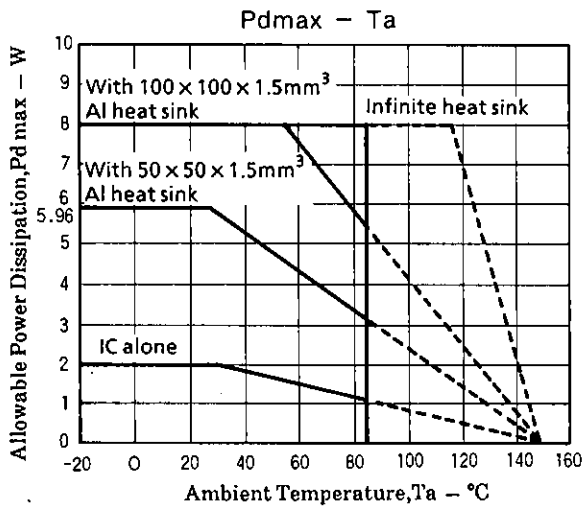

# LA7837, 7838

## LA7837, 7838 Interface Circuit

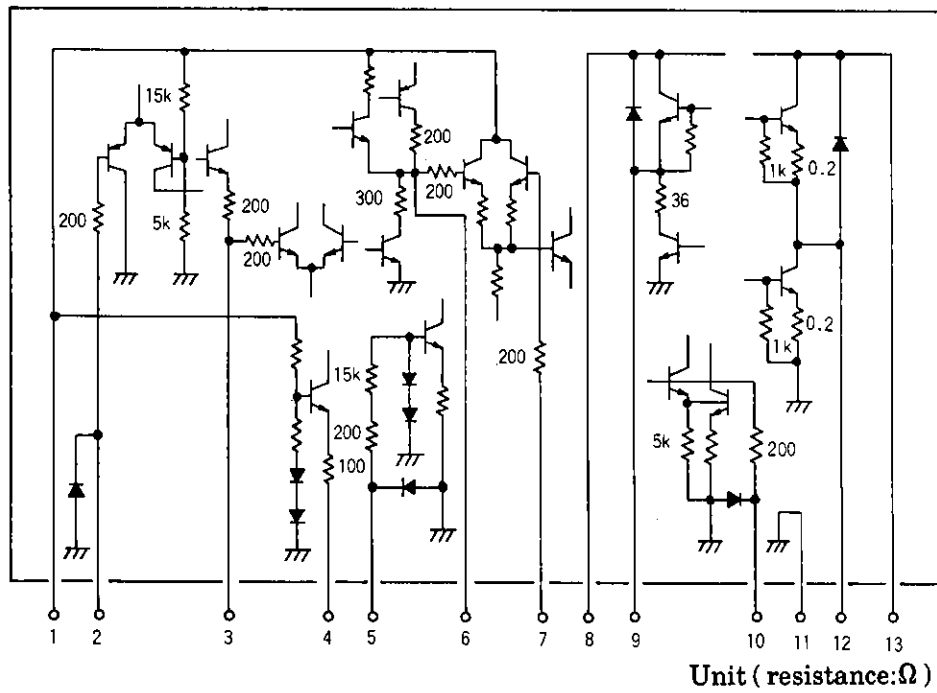

## LA7837, 7838 Pin Connection Diagram and Block Diagram

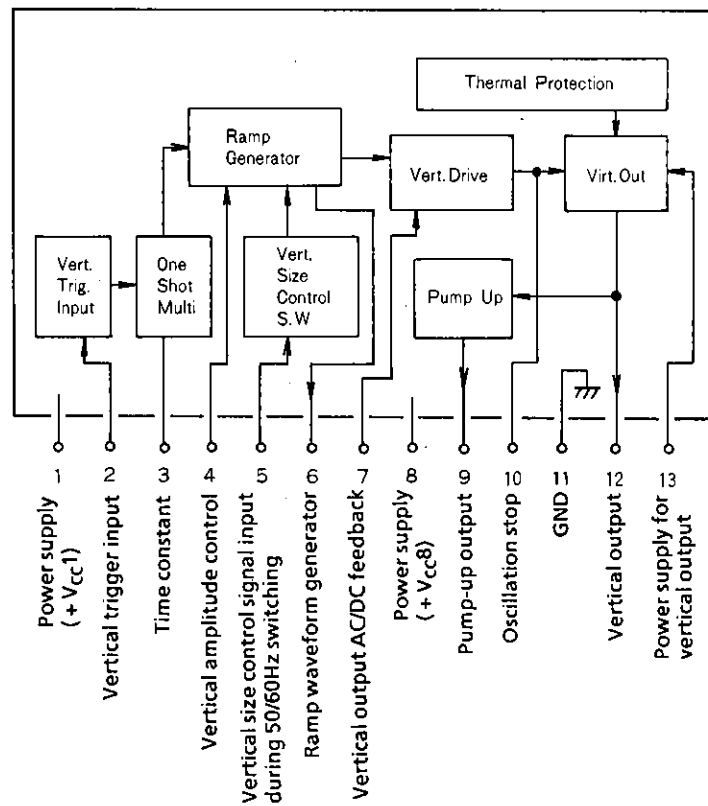

# LA7837, 7838

## Sample Application Circuits for 14" Color TV

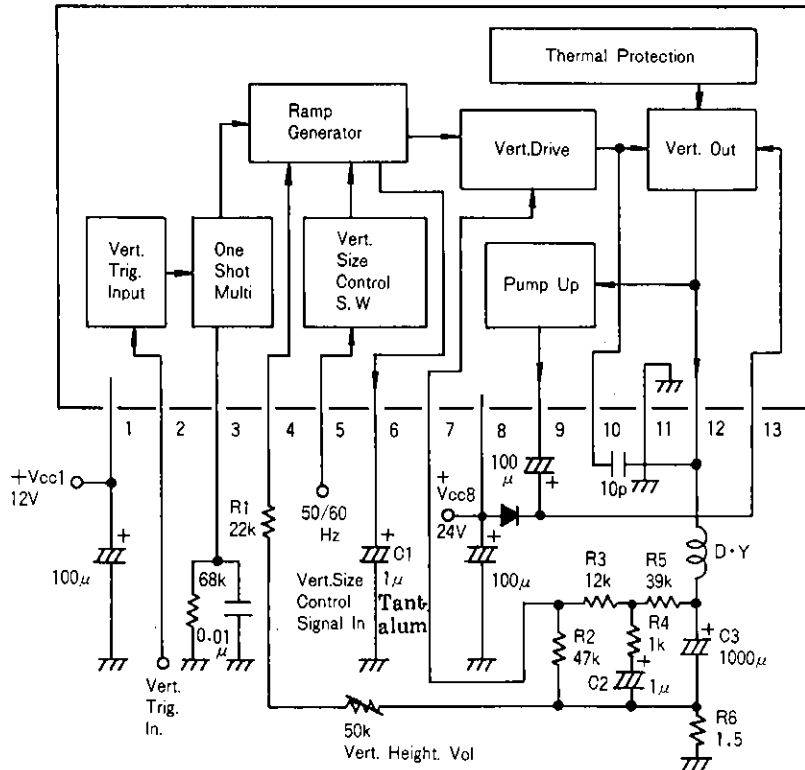

Fig.1 +Vcc1, 12V

Unit (resistance:Ω, capacitance:F)

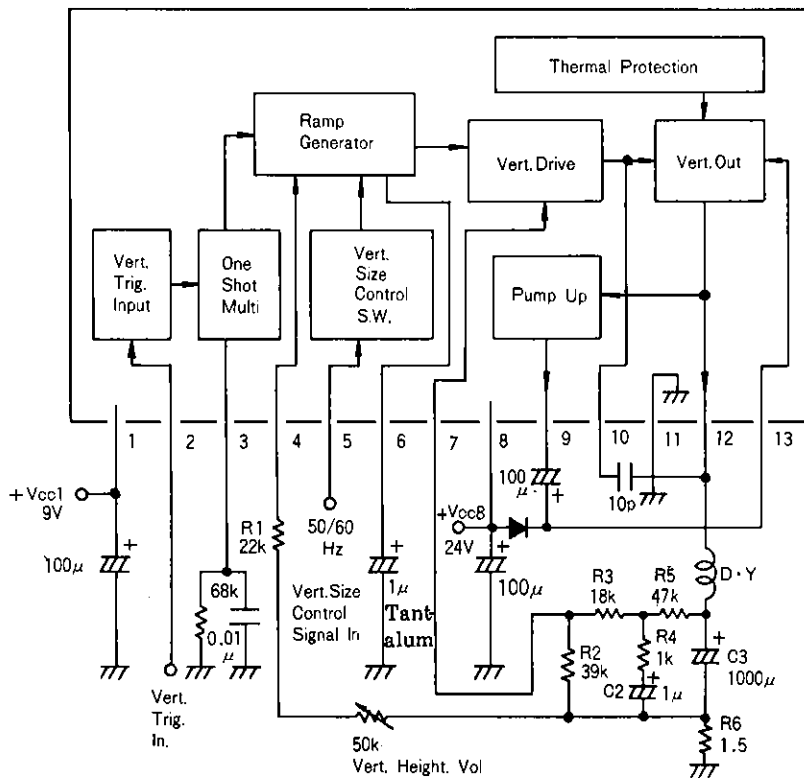

Fig.2 +Vcc1, 9V

Unit (resistance:Ω, capacitance:F)

# LA7837, 7838

## Sample Application Circuit for 14" Display (Retrace Time $\approx 300\mu\text{s}$ )

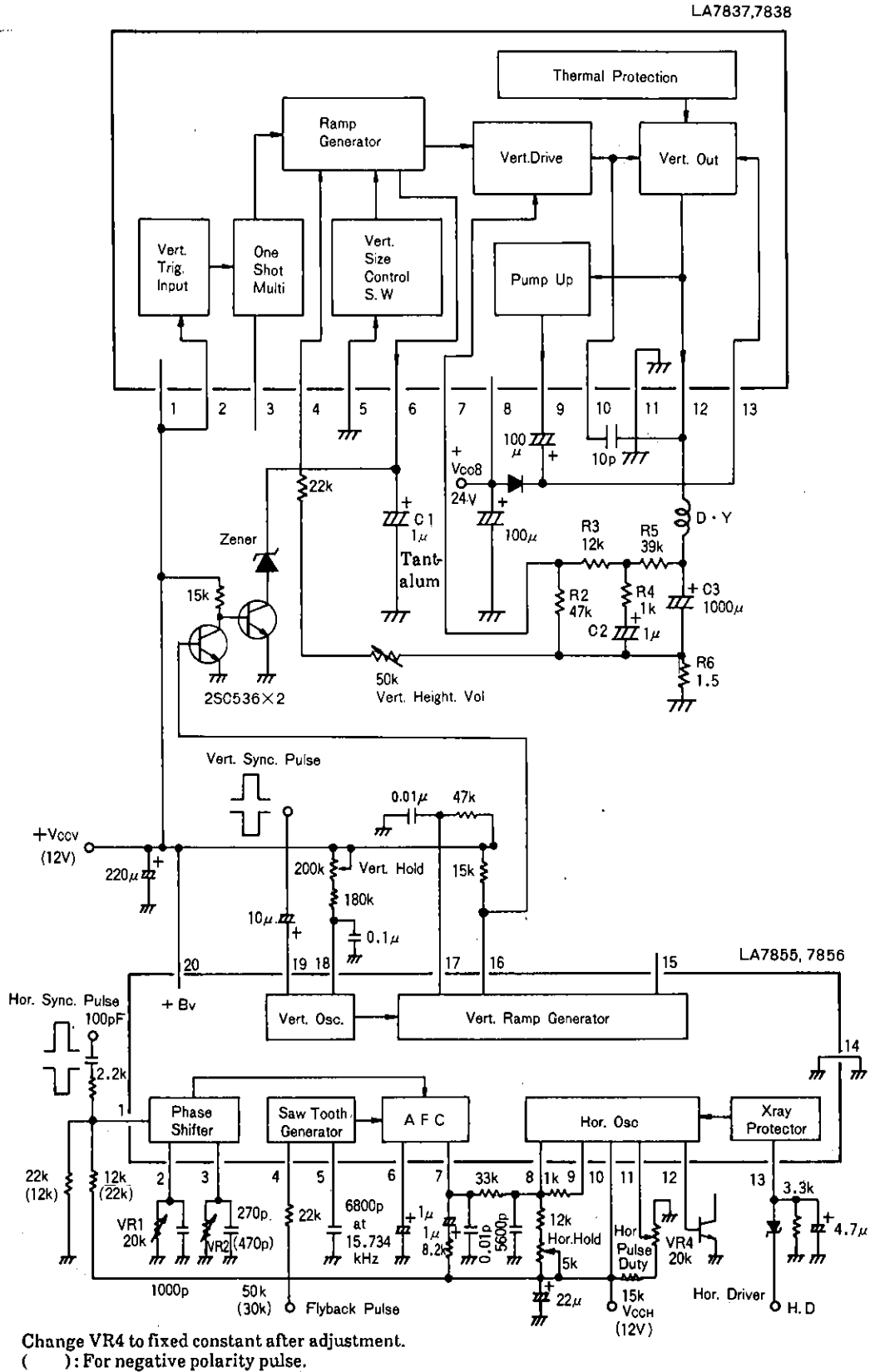

Fig.3

Unit ( resistance:Ω, capacitance:F )

**Precautions when using with display having short retrace time :**

The vertical output ICs LA7837,7838 are appropriate for use in monitors and displays because the interlace and crossover distortion responses are superior to those of the LA7835,7836.

However, since the vertical retrace time of displays is shorter than that of TV, the upper portion of the vertical picture may stretch. This is because the start waveform of the pin 6 sawtooth wave bends, as shown in Fig.4, due to the diode response of the clamp waveform. If there is not much time difference between  $T_1$  and  $T_R$ , the upper portion of the vertical picture will tend to stretch. The use of a circuit as shown in Fig.3 will cause pin 6 waveform start wave to become linear, so that stretching is suppressed. The example of circuit application shown in Fig.3 does not use the trigger input circuit (pin 2) and one-shot multivibrator (pin 3) built in the LA7837,7838 ; the pin 6 sawtooth wave is controlled by the LA7855,7856 vertical output pulse.

Therefore, the discharge circuit and clamp circuit are formed by the external Zener diode and transistor TR2.

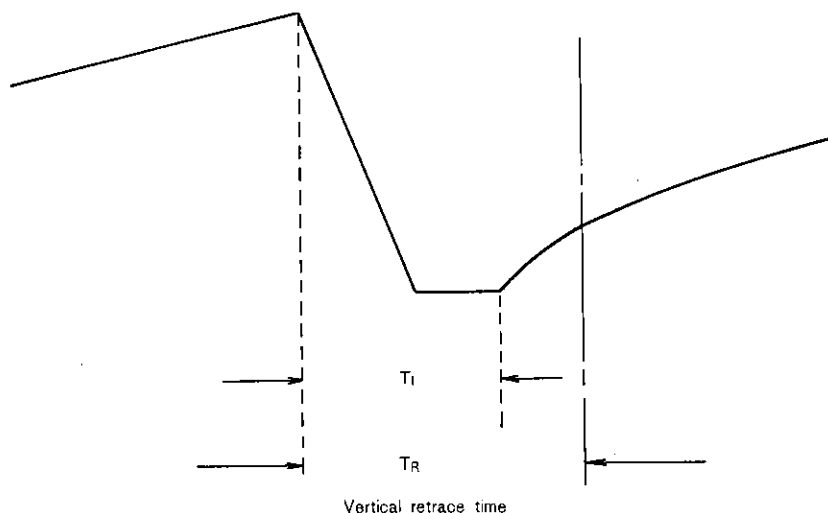

Fig.4

**Design Example**

For 12V pin 1 power supply

On the LA7837,7838, pin 3 one-shot multivibrator operates when a trigger pulse enters pin 2. During this time, the sawtooth wave generator discharge circuit and clamp circuit inside pin 6 operate.

The clamp voltage at this time is figured according to this formula :

$$V_{CLAMP} = 5/12 \cdot V_{CC} \dots\dots\dots \textcircled{1}$$

For 12V,

$$V_{CLAMP} = 5 [V]$$

Therefore, the Zener diode used in Fig.3 must be rated more than 5V (e.g. 5.6V), otherwise the clamp circuit inside the IC will operate.

For 9V pin 1 power supply

The same as for 12V, according to formula  $\textcircled{1}$  :

$$V_{CLAMP} = 3.75 [V]$$

So, the Zener diode must be rated more than 4V (e.g. 4.5V).

# LA7837, 7838

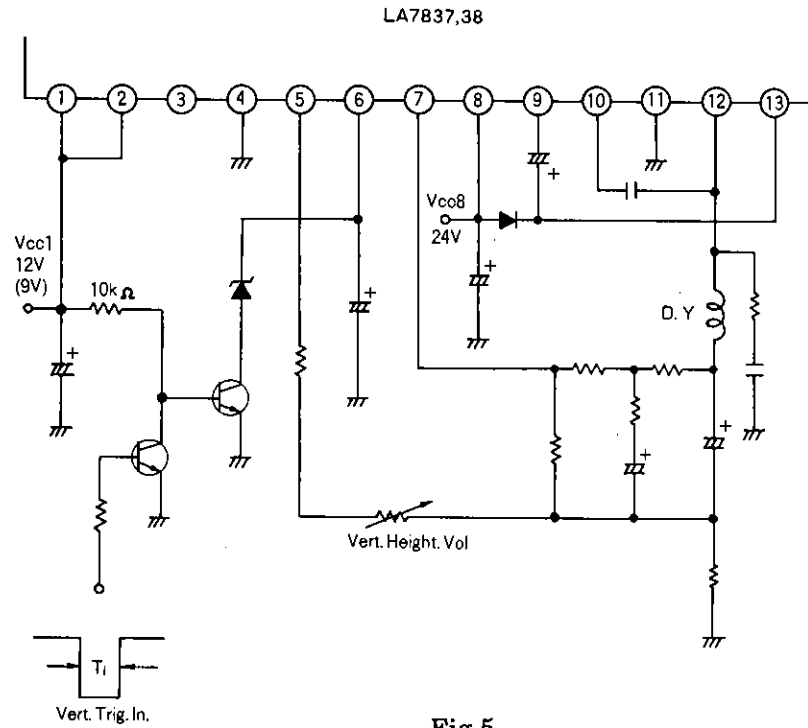

Fig.5

Pin 6 waveform when using the LA7837,7838 in a display application circuit (Fig.3)

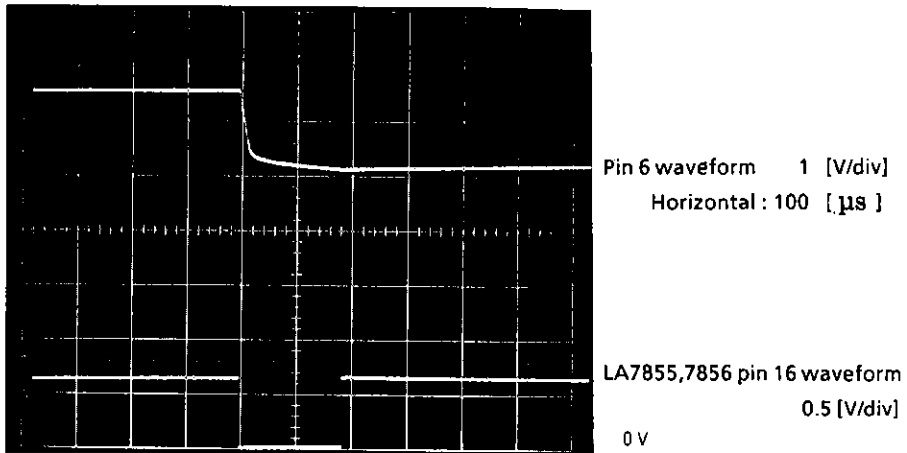

Fig.6

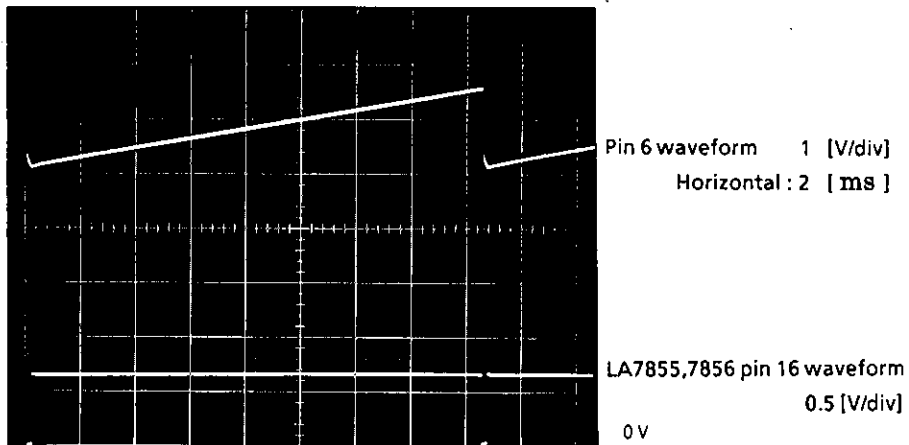

Fig.7

LA7837,7838 application in a multi-sync system

The LA7837,7838 can also be used in a vertical frequency multi-sync system.

The LA7837,7838 do not have an on-chip vertical oscillation circuit, so they operate merely by impressing a trigger pulse (e.g.40 to 80Hz) on pin 2.

However, there are two problems with using the LA7837,7838 as are in a multi-sync system.

One is vertical amplitude. When the trigger pulse changes between 40 to 80Hz, the vertical frequency will rise and amplitude size decreases (because pin 6 cycle (T1,T2) in the diagram below becomes shorter).

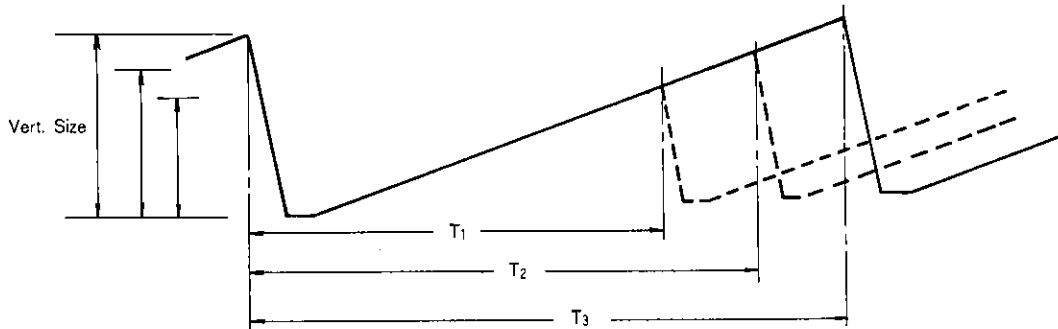

Fig.8

Countermeasure 1

In order to stabilize vertical size change, an op amp is used to change the circuit to one which controls pin 4 vertical size control current.

Voltage which corresponds to vertical frequency changes is applied to the op amp to stabilize vertical size.

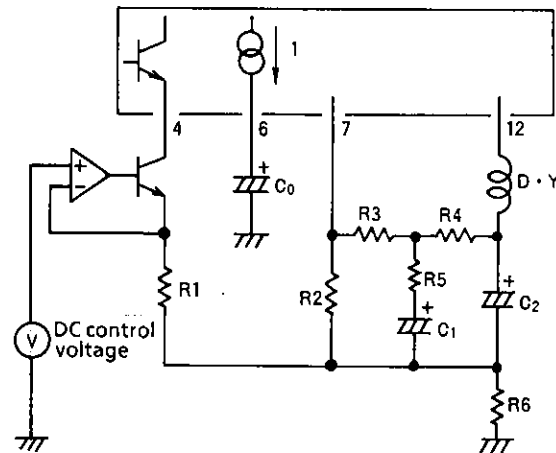

Fig.9

The other problem is that vertical linearity changes when used at multi-frequency (e.g. 40 to 80Hz).

The reason for this is that R5 and C1 time constants are used for linearity correction (Fig.9), so even though the value is optimum for a certain frequency, it is not for others.

Countermeasure 2

As shown in Fig.10, good linearity can be obtained by setting frequency ranges of use for R5 and C1 time constants for vertical linearity correction, and switching them.

For example :

40 to 60Hz Switch A

60 to 80Hz Switch B

For switch A, R5 and C1 are set so that vertical linearity response is optimum for  $f_v \cong 50\text{Hz}$ .

Next, for switch B, R5' and C1' are set for optimum value at  $f_v \cong 70\text{Hz}$ .

By dividing the vertical trigger pulse range (e.g.40 to 80Hz) and performing linearity correction in this way, linearity distortion can be kept below about 3%.



## Reference

For example, when using the LA7837,7838 on a multi-sync system with 40 to 80Hz vertical frequency, vertical linearity distortion will be less than approximately 4%, if vertical size is always uniform.

Therefore, if linearity response of better than 4% is desired, the linearity correction time constant switching circuit shown in Fig.10 should be used.

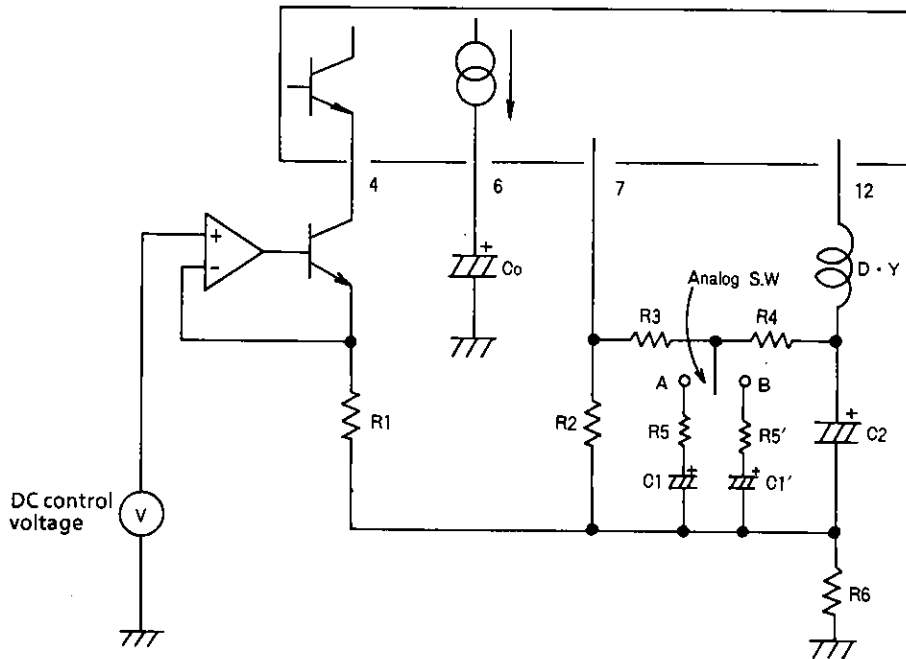

Fig.10

- No products described or contained herein are intended for use in surgical implants, life-support systems, aerospace equipment, nuclear power control systems, vehicles, disaster/crime-prevention equipment and the like, the failure of which may directly or indirectly cause injury, death or property loss.
- Anyone purchasing any products described or contained herein for an above-mentioned use shall:
  - ① Accept full responsibility and indemnify and defend SANYO ELECTRIC CO., LTD., its affiliates, subsidiaries and distributors and all their officers and employees, jointly and severally, against any and all claims and litigation and all damages, cost and expenses associated with such use:
  - ② Not impose any responsibility for any fault or negligence which may be cited in any such claim or litigation on SANYO ELECTRIC CO., LTD., its affiliates, subsidiaries and distributors or any of their officers and employees jointly or severally.
- Information (including circuit diagrams and circuit parameters) herein is for example only; it is not guaranteed for volume production. SANYO believes information herein is accurate and reliable, but no guarantees are made or implied regarding its use or any infringements of intellectual property rights or other rights of third parties.

This catalog provides information as of June , 1996 . Specifications and information herein are subject to change without notice.