



No. 5153

LA7685J

PAL/NTSC Single-chip Color Television Signal Processing Circuit

Overview

The LA7685J is a single-chip IC (with VIF, SIF, video, chroma, and deflection circuits built in) for use in PAL or NTSC television sets.

Because the PLL+ splitting method is used in the VIF circuit, the LA7685J is suited for use in top-of-the-line small and mid-size television sets. In addition, when used in combination with the LA7640N SECAM chroma IC, the LA7685J can be used in a PAL/NTSC/SECAM multisystem set.

Features

[VIF Block]

- PLL+ splitting (for excellent image and sound quality)
- High-gain VIF amplifier
- High-speed AGC
- APC time constant switch built in

[SIF Block]

- Simultaneous audio IN/OUT
- Video/audio simultaneous muting, or audio only muting also possible
- 1st amplifier with AGC function

[AV Switching Block]

- INT/EXT AV switch

Delay line	Video EXT, audio EXT	Switch conditions
OFF	IN	D
OFF	EXT	C
ON	EXT	B
ON	IN	A

[OSD Block]

- Three RGB inputs
- RGB linear amplifier (-6 dB input: 2 V to 5 V)
- First blanking (also used for B input)

[Chroma Block]

- ACC filter, carrier filter built in
- Ident detection output
- Killer detection output

[Video Block]

- Black extension
- DC restoration
- Delay line built in
- Wide band: 9 MHz (with delay line shorted)
- Built-in double differential circuits that also enable soft tone
- Supports S input (for VCRs)
- DC transmission amount can be varied (externally adjustable)

[Deflection Block]

- Adjustment-free horizontal and vertical sync
- Excellent anti-noise characteristics due to adoption of duplex AFC
- Vertical sync sensitivity can be adjusted externally
- Constant vertical size with no signal (constant for 60/50 Hz)
- Highly stable image during copy guard tape playback (macrovision tapes, etc.)
- Excellent stability against VCR skew distortion

Package Dimensions

unit : mm

3071-DIP64S

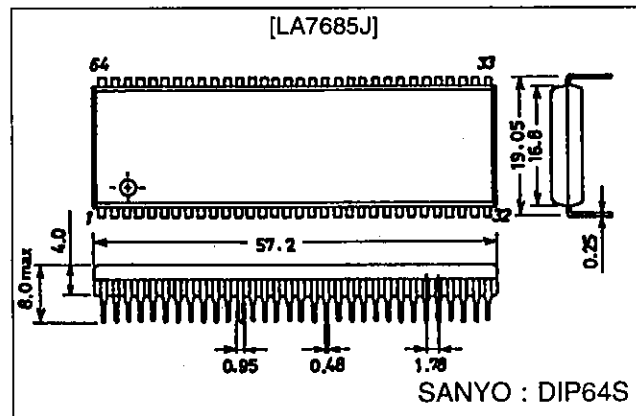

Specifications

Maximum Ratings at Ta = 25 °C

Parameter	Symbol	Conditions	Ratings	Unit
Maximum supply voltage	V ₂ max		11	V
	V ₁₂ max		11	V
Maximum supply current	I ₃₂ max		16	mA
Allowable power dissipation	Pd max	Ta ≤ 60 °C	1.53	W
Operating temperature	Topr		-10 to +65	°C
Storage temperature	Tstg		-55 to +150	°C
Circuit current	I ₅₆		-6	mA
	I ₆		-3	mA
FBP input current	I ₃₃ max	Peak current	5	mA
	I ₂₇ max	Peak current	10	mA

Operating Conditions at Ta = 25 °C

Parameter	Symbol	Conditions	Ratings	Unit
Recommended supply voltage	V ₂		9	V
	V ₁₂		9	V
Recommended supply current	I ₃₂		13	mA
Operating supply voltage range	V _{2op}		8 to 9.5	V
	V _{12op}		8 to 9.5	V
Operating supply current range	I _{32op}		10 to 16	mA

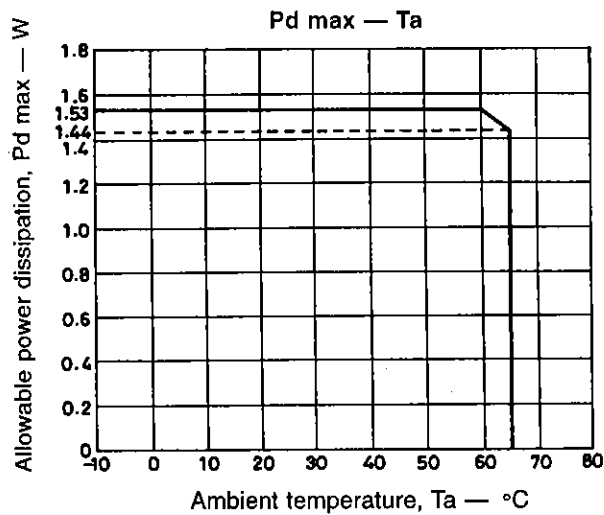

LA7685J

Electrical Characteristics at $T_a = 25^\circ\text{C}$, $V_{CC} = V_2 = V_{12} = 9\text{ V}$, $I_{CC} = I_{32} = 13\text{ mA}$

Parameter	Symbol	Conditions	min	typ	max	Unit
[Circuit Voltage, Current]						
Horizontal supply voltage	V_{32}	$V_{CC} = 9\text{ V}$, $I_{CC} = 13\text{ mA}$	7.1	7.6	8.1	V
Supply current	$I_2 + I_{12}$	$V_{CC} = 9\text{ V}$, $I_{CC} = 13\text{ mA}$, $I_{FAGC} = 4\text{ V}$	102	120	138	mA
[VIF Block] $f_p = 38.9\text{ MHz}$						
Video output voltage with no signal	V_{56}	No signal	4.3	4.7	5.1	V
AFT output voltage with no signal	V_{60}	No signal	3.0	4.5	6.0	V
Maximum RF AGC voltage	V_{5H}	$CW = 85\text{ dB}\mu$, RF AGC VR = min	7.6	8.0	8.3	V
Minimum RF AGC voltage	V_{5L}	$CW = 85\text{ dB}\mu$, RF AGC VR = max	0	0.01	0.3	V
Input sensitivity	V_i	Video output is 0.8 Vp-p (40% MOD), VIF input level	33	39	45	dB μ
AGC range	GR	Maximum input ($V_0 = 0.8\text{ Vp-p}$) - Input sensitivity	54	62		dB
Maximum allowable input	$V_{i\text{ max}}$	Video output is +1 dB, VIF input level	97	104		dB μ
Video output amplitude	V_{O56}	$V_i = 80\text{ dB}\mu$, AM = 78% MOD	1.7	2.0	2.3	Vp-p
Differential gain	DG	$V_i = 80\text{ dB}\mu$, 87.5%, VIDEO MOD		3.0	10	%
Differential phase	DP	$V_i = 80\text{ dB}\mu$, 87.5%, VIDEO MOD		1.0	10	deg
Video S/N	S/N	$V_i = 80\text{ dB}\mu$, $20 \log \frac{1.46\text{ (Vp-p)}}{\text{Noise (Vrms)}}$	47	54		dB
Sync signal tip level	$V_{56\text{ TIP}}$	$CW = 80\text{ dB}\mu$	2.1	2.4	2.7	V
Frequency characteristics	f_C	Frequency when video output is -3 dB	6.5	8.0		MHz
1.07 kHz beat level	$I_{1.07}$	$V_{4.43\text{ MHz}/V_{1.07\text{ MHz}}}$, $V_i = 80\text{ dB}\mu$	35	50		dB
Maximum AFT output voltage	V_{60H}	$CW = 80\text{ dB}\mu$, frequency change	7.6	8.0	8.4	V
Minimum AFT output voltage	V_{60L}	$CW = 80\text{ dB}\mu$, frequency change	0.6	1.0	1.4	V
AFT detection sensitivity	S_f	$CW = 80\text{ dB}\mu$, frequency change	50	80	110	mV/kHz
AFT defeat start voltage	$V_{\text{AFT SW}}$	Measure with sweep signal	0.5	1.0		V
Black noise threshold level	V_{BTH}	Measure with sweep signal	1.1	1.4	1.7	V
APC pull-in range (U)	f_{PU}	$CW = 80\text{ dB}\mu$, $f_p = 34\text{ MHz to }44\text{ MHz}$	0.8	1.7		MHz
APC pull-in range (L)	f_{PL}	$CW = 80\text{ dB}\mu$, $f_p = 53\text{ MHz to }64\text{ MHz}$		-2	-1	MHz
VCO maximum variable range	Δf_U	No signal	0.9	1.7		MHz
	Δf_L	No signal		-2	-1	MHz
VCO control sensitivity	β	No signal	1.3	2.5	5.3	kHz/mV
[AVSW Block]						
Image output DC voltage	V_{50}	No signal	3.0	3.4	3.8	V
Internal image input voltage	V_{54}	No signal	4.4	4.8	5.2	V
External image input voltage	V_{52}	No signal	4.4	4.8	5.2	V
External audio input voltage	V_4	No signal	5.2	5.6	6.0	V
[1st SIF Block]						
5.5 MHz conversion gain	VG	$V_i = 70\text{ dB}\mu$, 33.4 MHz	21	26	31	dB
Output level	V_{59}	$V_i = 10\text{ mV}$, 33.4 MHz	210	320	480	mVp-p
Maximum input level	$V_{11\text{ max}}$	$f_S = 33.4\text{ MHz}$	96	101		dB μ
[SIF ATT Block] $f_S 5.5\text{ MHz}$						
SIF limiting voltage	$V_{i\text{ lim}}$	SIF input when detection output is -3 dB.		40	47	dB μ
FM detection output voltage	V_{O1}	$V_i = 100\text{ dB}\mu$, $\Delta f = \pm 30\text{ kHz}$	390	500	630	mVrms
FM detection output distortion	THD	$V_i = 100\text{ dB}\mu$, $\Delta f = \pm 30\text{ kHz}$		0.4	1.0	%
AM rejection ratio	AMR	$V_i = 100\text{ dB}\mu$, $\frac{\text{FM : } \Delta f = \pm 30\text{ kHz}}{\text{AM : } 30\%}$	40	60		dB
ATT voltage gain	G_{AF}	$V_i = 1\text{ Vrms}$, $f = 400\text{ Hz}$	-1	0	1	dB
Maximum attenuation of electronic volume control	ATT	$V_i = 2\text{ Vrms}$, $f = 400\text{ Hz}$	70	80		dB
[Video Block]						
Black extension threshold	BS_{TH}	APL variable, input 0.5 Vp-p	40	50	60	IRE
Maximum black extension gain	BS_{max}	APL variable, input 0.5 Vp-p	-30	-22	-13	IRE
Soft video tone variable range	ΔSoft	$f = 2\text{ MHz}$, 100 mVp-p Video tone $V_R : 4\text{ V} \rightarrow 0\text{ V}$	-6	-4	-2	dB

Continued on next page.

LA7685J

Continued from preceding page.

Parameter	Symbol	Conditions	min	typ	max	Unit
Sharp video tone variable range	Δ Sharp	$f = 2 \text{ MHz}$, 100 mVp-p, video tone $V_R : 4 \text{ V} \rightarrow 9 \text{ V}$, contrast $V_R : 6 \text{ V}$	7	10	13	dB
Video voltage gain AC switch 9 V	GV _{9V}	$f = 100 \text{ kHz}$, 100 mVp-p, contrast $V_R : 9 \text{ V}$, video tone $V_R : 4 \text{ V}$	15	18	21	dB
Video voltage gain AV switch 0 V	GV _{0V}	$f = 100 \text{ kHz}$, 100 mVp-p, contrast $V_R : 0 \text{ V}$, video tone $V_R : 4 \text{ V}$	15	18	21	dB
Contrast control center	C _{CEN}	$f = 100 \text{ kHz}$, 100 mVp-p, contrast $V_R : 6 \text{ V}$	0.35	0.44	0.53	Vp-p
Contrast control variable range	Δ C _V	Contrast $V_R : 3 \text{ V} \rightarrow 9 \text{ V}$	22	24	26	dB
Bright control	BR _H	Bright $V_R : 2.0 \text{ V}$	5.5	6.5	7.5	V
	BR _{CEN}	Bright $V_R : 5.25 \text{ V}$	2.3	2.8	3.3	V
	BR _L	Bright $V_R : 7.5 \text{ V}$		0.5	1.5	V
Frequency characteristics D.L.ON	f _{0V}	Contrast $V_R : 6 \text{ V}$, video tone $V_R : 4 \text{ V}$, 3 dB down	4.5	6		MHz
DC transmission amount	R _{DC}	Input : STAIR STEP signal, 200 mVp-p	88	93		%
Delay line delay amount (one level)	T _{DL1}	Input : WHITE 100 %	300	350	400	ns
Delay line delay amount (two levels)	T _{DL2}	Input : WHITE 100 %	370	420	470	ns
[Chroma Block PAL/NTSC Common]						
Color control color residue	E _{Cmin}	Color $V_R : 0 \text{ V}$, contrast $V_R : 9 \text{ V}$			30	mVp-p
Color contrast variable range	Δ C _C	Color $V_R : B-Y = 2.5 \text{ Vp-p}$, contrast $V_R : 3 \text{ V} \rightarrow 9 \text{ V}$	18.5	20	21.5	dB
Demodulation output DC voltage	V _{C-Y}	Burst signal only, color $V_R : 0 \text{ V}$	4.8	5.3	5.8	V
Demodulation output DC difference voltage	Δ V _{C-Y}	Burst signal only, color $V_R : 0 \text{ V}$	-300	0	+300	mV
Demodulation output carrier leakage	E _{car}	No signal, killer off, color $V_R : 0 \text{ V}$			0.03	Vp-p
APC pull-in range	Δ F _{APC}		± 500			Hz
Kill output	V _{KIOUT}				0.35	V
[Chroma Block PAL]						
Color control center	E _{CEN}	Color $V_R : 4.5 \text{ V}$, contrast $V_R : 6 \text{ V}$	1.5	2.0	2.5	Vp-p
ACC amplitude characteristics	ACC _{M1P}	+6 dB	-3	0	+3	dB
	ACC _{M2P}	-20 dB	-5	-1	+1	dB
Demodulation output ratio	B/Rp		1.10	1.35	1.60	
	G/Rp	B-Y no signal	-0.56	-0.51	-0.46	
	G/Bp	R-Y no signal	-0.21	-0.19	-0.17	
Demodulation angle	RBp		85	90	95	deg
Maximum chroma output	E _{ch}	Color $V_R : 9 \text{ V}$, contrast $V_R : 9 \text{ V}$	1.5	2.0	2.5	Vp-p
Maximum demodulation output	E _{Cmax}	Color $V_R : 9 \text{ V}$, contrast $V_R : 9 \text{ V}$	3.6	4.2		Vp-p
Killer operating point	E _{KONP}		-37	-33	-29	dB
PAL output					0.3	V
[Chroma Block NTSC]						
Color control center	E _{CEN}	Color $V_R : 4.5 \text{ V}$, contrast $V_R : 6 \text{ V}$	1.4	1.9	2.4	Vp-p
ACC amplitude characteristics	ACC _{M1N}	+6 dB	-3	0	+3	dB
	ACC _{M2N}	-20 dB	-3	0	+3	dB
ACC phase characteristics	ACC _{P1N}	+6 dB	-3	0	+3	deg
	ACC _{P2N}	-20 dB	-7	0	+7	deg
Tint center	T _{CEN}	Tint $V_R = 4.5 \text{ V}$, color $V_R : 4.5 \text{ V}$, contrast $V_R : 6 \text{ V}$	-12	0	+12	deg
Tint variable range	Δ T	Tint $V_R : 0 \text{ V} \leftarrow 4.5 \text{ V} \rightarrow 9 \text{ V}$, color $V_R : 4.5 \text{ V}$, contrast $V_R : 6 \text{ V}$	± 35			deg
Demodulation output ratio	R/B _N		0.82	0.91	0.99	
	G/B _N		0.18	0.25	0.32	
Demodulation angle	RB _N		99	105	111	deg
	GB _N		-130	-120	-110	deg
Maximum demodulation output	E _{CmaxN}	Color $V_R : 9 \text{ V}$, contrast $V_R : 9 \text{ V}$	3.5	4.1		Vp-p
Kill operation point	E _{KONN}		-39	-35	-31	dB
NTSC/SECAM output	E _{KONN}		1.4	1.9	2.4	V

Continued on next page.

LA7685J

Continued from preceding page.

Parameter	Symbol	Conditions	min	typ	max	Unit
[Deflection Block]						
Sync separation input voltage	$V_{S\ DC}$		6.0	6.3	6.6	V
Vertical free-running frequency	$T_{V\ free50}$		312.0	312.5	313.0	H
	$T_{V\ free60}$		262.0	262.5	263.0	H
Vertical sync maximum period	$T_{V\ max50}$	Horizontal sync signal only	356.5	357	357.5	H
	$T_{V\ max60}$	Horizontal sync signal only	296.5	297	297.5	H
Vertical sync minimum period	$T_{V\ min50}$		268.5	269	269.5	H
	$T_{V\ min60}$		224.5	225	225.5	H
Vertical blanking pulse peak value	V_{HVBL}		7.0	7.5		V
Vertical blanking pulse width	P_{WBLK50}		21.0	21.5	22.0	H
	P_{WBLK60}		17.0	17.5	18.0	H
Vertical output pulse width	P_{WVOUT}		8.0	8.5	9.0	H
Vertical output voltage	$V_{OUT\ H}$		5.7	6	6.3	V
	$V_{OUT\ M}$		4.3	4.6	4.9	V
	$V_{OUT\ L}$				0.3	V
Vertical external trigger load resistance	R_{TR}		2.5	3.6		k Ω
Vertical automatic sync stop voltage	V_{SAS}		1.2	1.4	1.6	V
Vertical output pulse start V_{CC} voltage	S_{VV}				4	V
Horizontal free-running frequency deviation	Δf_H	Deviation from 15.680 kHz	-100	0	+100	Hz
Dependence of horizontal free-running frequency on V_{CC}	Δf_{HVCC}	$V_{25} = 6.5\ V$, reference value		2		Hz
Horizontal pull-in range	f_{HPULL}	Deviation from 15.680 kHz	± 450			Hz
Horizontal output pulse start V_{CC} voltage	S_{HV}			4.8	5.5	V
AFC II FBP peak value	FBP_H		4.1	4.6	5.1	V
VCR switch input voltage	V_{CR}			0.7	0.9	V
Horizontal output pulse width	P_{WHOUT}		21.8	23.8	25.8	μs
	H_{PF}		12			μs
	H_{PCEN}		3.4	4.4	5.4	μs
	H_{PR}				0	μs
Burst gate pulse width	P_{WBGP}		2.7	3.7	4.7	μs
Burst gate pulse phase	T_{dBGP}		0.2	0.6	1.2	μs
Horizontal sync detection threshold level	H_{coin}		4.2	4.5	4.8	V
50/60 output voltage	V_{50}			0.5	0.7	V
	V_{60}		4.0	4.7		V
50/60 input voltage	V_{in50}				0.5	V
	V_{in60}		7.2			V
X ray protection circuit operation input voltage	V_{HD}		0.64	0.74	0.84	V
Sandcastle H.BLK peak value	$V_H\ SHBL$		3.7	4.0	4.3	V
Sandcastle BGP peak value	$V_H\ SBGP$		7.7	8.0	8.3	V
Sandcastle BP peak value	$V_H\ SBP$		5.7	6.0	6.3	V
Sandcastle BGP width	$P_W\ SBGP$		1.4	1.9	2.4	μs
Sandcastle BGP phase	$T_d\ SBGP$		1.7	2.2	2.7	μs
Sandcastle field ID width	$P_W\ SFID$		11.5	12	12.5	H
Sandcastle H.BLK width 50	$P_W\ SHBL50$		11.0	12.0	13.0	μs
Sandcastle H.BLK width 60	$P_W\ SHBL60$		10.0	11.0	12.0	μs

Continued on next page.

LA7685J

Continued from proceeding page.

Parameter	Symbol	Conditions	min	typ	max	Unit
[OSD Block]						
Blanking pulse threshold level	TH _{BL}	C-IN : color bar, B-IN : variable	0.6	0.9	1.2	V
-Y OUT DC voltage (OSD mode)	V _Y	B-IN : 1.5 V	2.4	2.7	3.0	V
R.G.B. -IN threshold level	TH _R	R-IN : variable, B-IN : 1.5 V	1.4	1.7	2.0	V
	TH _G	G-IN : variable, B-IN : 1.5 V				
	TH _B	B-IN : variable				
R.G.B. -Y OUT DC voltage (3 V)	V _{R3V}	R, G, B-IN : 3 V	5.2	5.5	5.8	V
	V _{G3V}					
	V _{B3V}					
R.G.B. -Y OUT DC voltage (4 V)	V _{R4V}	R, G, B-IN : 4 V	5.8	6.1	6.4	V
	V _{G4V}					
	V _{B4V}					
R.G.B. -Y OUT DC voltage (5 V)	V _{R5V}	R, G, B-IN : 5 V	6.3	6.6	6.9	V
	V _{G5V}					
	V _{B5V}					

LA7685J

LA7685J and LA7640N Connection Diagram (Reference)

Unit (resistance: Ω, capacitance: F)

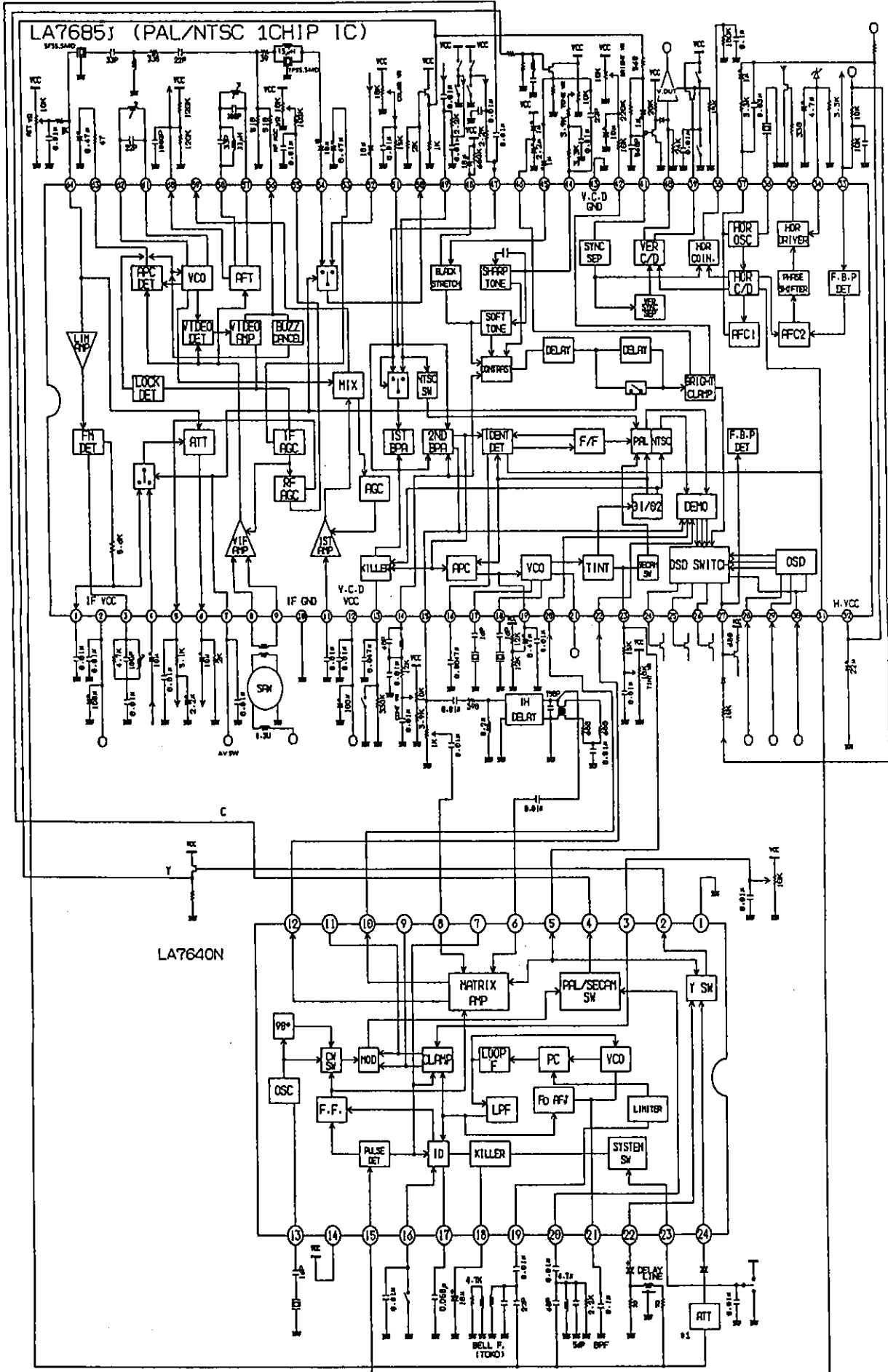

- No products described or contained herein are intended for use in surgical implants, life-support systems, aerospace equipment, nuclear power control systems, vehicles, disaster/crime-prevention equipment and the like, the failure of which may directly or indirectly cause injury, death or property loss.
- Anyone purchasing any products described or contained herein for an above-mentioned use shall:
 - ① Accept full responsibility and indemnify and defend SANYO ELECTRIC CO., LTD., its affiliates, subsidiaries and distributors and all their officers and employees, jointly and severally, against any and all claims and litigation and all damages, cost and expenses associated with such use:
 - ② Not impose any responsibility for any fault or negligence which may be cited in any such claim or litigation on SANYO ELECTRIC CO., LTD., its affiliates, subsidiaries and distributors or any of their officers and employees jointly or severally.
- Information (including circuit diagrams and circuit parameters) herein is for example only; it is not guaranteed for volume production. SANYO believes information herein is accurate and reliable, but no guarantees are made or implied regarding its use or any infringements of intellectual property rights or other rights of third parties.

This catalog provides information as of June, 1995. Specifications and information herein are subject to change without notice.