

<b>SANYO</b>	No.1967B	<b>LA6082D,6082S</b>
		<b>J-FET Input Dual Operational Amplifiers</b>

The LA6082 is a J-FET input dual operational amplifier. Application areas include general-purpose control equipment, measuring equipment (very low current measurement, long-integrating circuit, sample & hold circuit, impedance converter, etc.).

**Features**

- . High slew rate
- . High input impedance
- . Low input bias current
- . Low input offset current
- . No phase compensation required

**Maximum Ratings at Ta=25°C**

			unit
Maximum Supply Voltage	$V_{CC}/V_{EE}$	$\pm 18$	V
Differential Input Voltage	$V_{ID}$	$\pm 30$	V
Common-Mode Input Voltage	$V_{IN}$ (Note)	$\pm 15$	V
Allowable Power Dissipation	$P_d$ max	570	mW
Operating Temperature	$T_{opr}$	-30 to +85	°C
Storage Temperature	$T_{stg}$	-55 to +125	°C

(Note) Allowable in the range of supply voltage. The above value is for  $V_{CC}=+15V$ ,  $V_{EE}=-15V$ .

**Operating Characteristics at Ta=25°C,  $V_{CC}=+15V$ ,  $V_{EE}=-15V$**

			min	typ	max	unit
Input Offset Voltage	$V_{IO}$	$R_S=50\text{ohms}$		5.0	15.0	mV
Input Offset Current	$I_{IO}$			5	200	pA
Input Bias Current	$I_B$			30	400	pA
Common-Mode Input Voltage Range	$V_{ICM}$		$\pm 10$			V
Common-Mode Rejection Ratio	CMR		70	76		dB
Large Amplitude Voltage Gain	VG	$R_L \geq 2\text{kohms}, V_o = \pm 10V$	25	200		V/mV
Maximum Output Voltage	$V_{opp1}$	$R_L \geq 10\text{kohms}$	$\pm 12$	$\pm 13.5$		V
	$V_{opp2}$	$R_L \geq 2\text{kohms}$	$\pm 10$	$\pm 12$		V

Continued on next page.

Package Dimensions 3001B-D8IC  
(unit: mm)

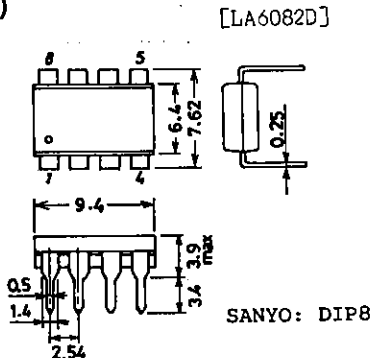

Package Dimensions 3017B-S9IC  
(unit: mm)

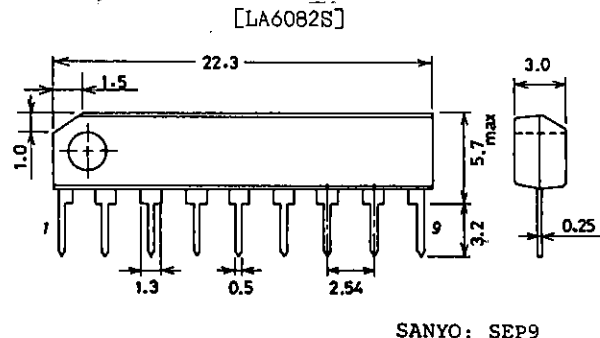

Continued from preceding page.

			min	typ	max	unit
Supply Voltage Rejection Ratio	SVR		70	76		dB
Supply Current	$I_{CC}$	$R_L = \infty$		4	5.6	mA
Gain-Bandwidth Product	$f_T$	$A_V = 1$		3		MHz
Equivalent Input Noise Voltage	$V_{NI}$	$R_S = 100\text{ohms},$ $f = 10\text{Hz to } 10\text{kHz}$		4		$\mu\text{Vrms}$
Input Resistance	$r_i$			$10^{12}$		ohm
Channel Separation	C·S			120		dB
Slew Rate	S·R	$R_L = 2\text{kohms}, C_i = 100\text{pF},$ $A_V = 1, V_{IN} = 10\text{V}$		13		V/us

Test Circuits

1. Input Offset Voltage  $V_{IO}$

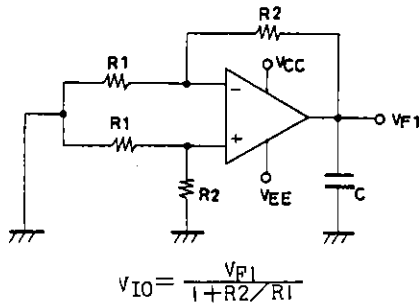

2. Input Offset Current  $I_{IO}$

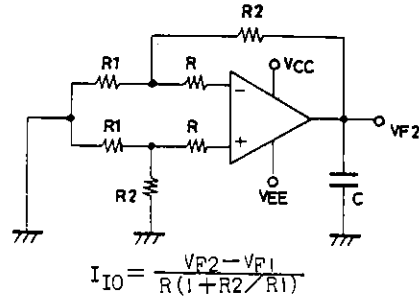

3. Input Bias Current  $I_B$

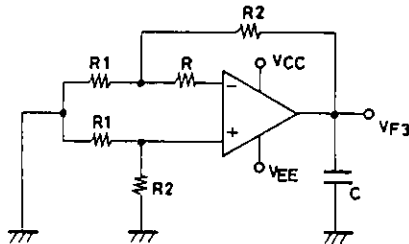

$$I_B = \frac{V_{F4} - V_{F3}}{2R(1 + R2/R1)}$$

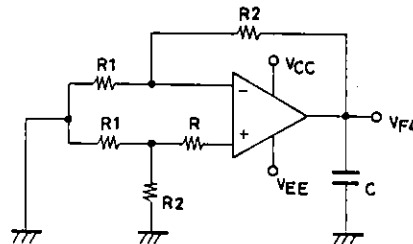

4. Common-Mode Rejection Ratio CMR  
Common-Mode Input Voltage Range  $V_{ICM}$

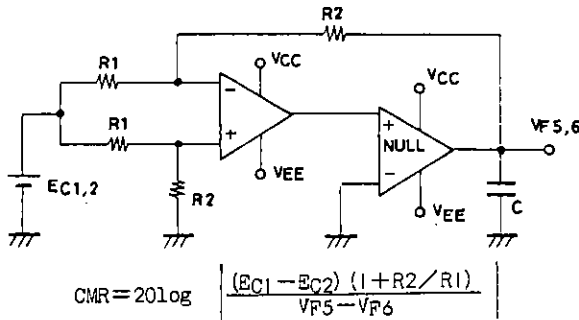

5. Voltage Gain VG

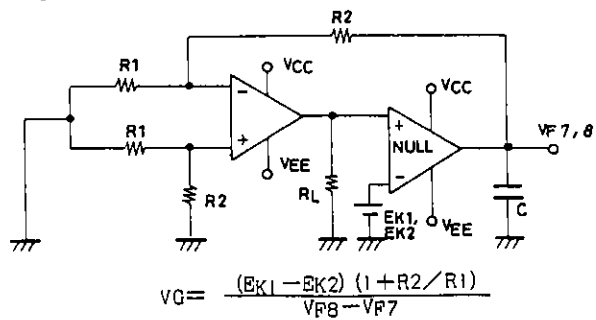

6. Maximum Output Voltage  $V_{opp}$

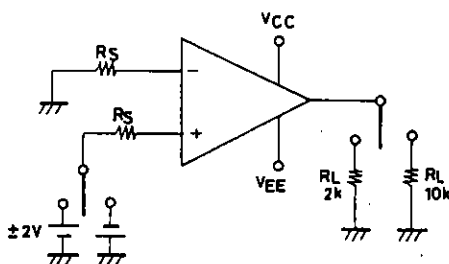

7. Supply Current  $I_{CC}$

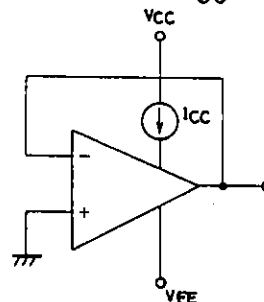

Unit (resistance:  $\Omega$ )

8. Supply Voltage Rejection Ratio SVR

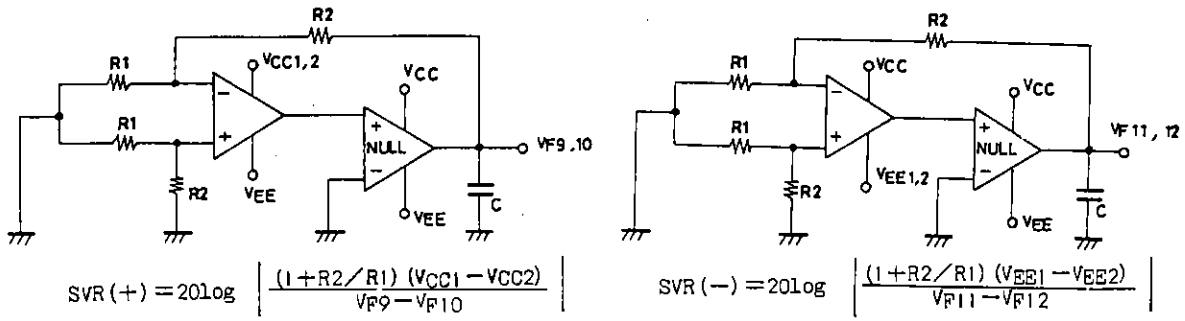

9. Equivalent Input Noise Voltage  $V_{NI}$  10. Slew Rate SR

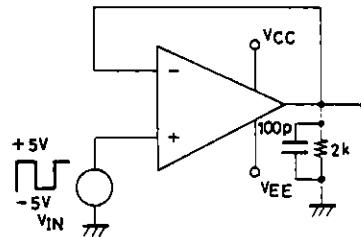
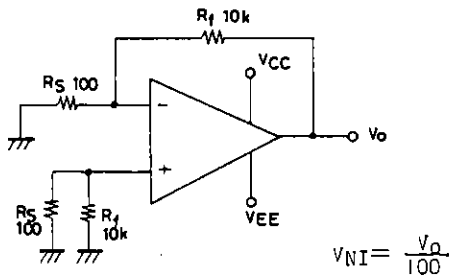

Equivalent Circuit

Unit (resistance:Ω capacitance:F)

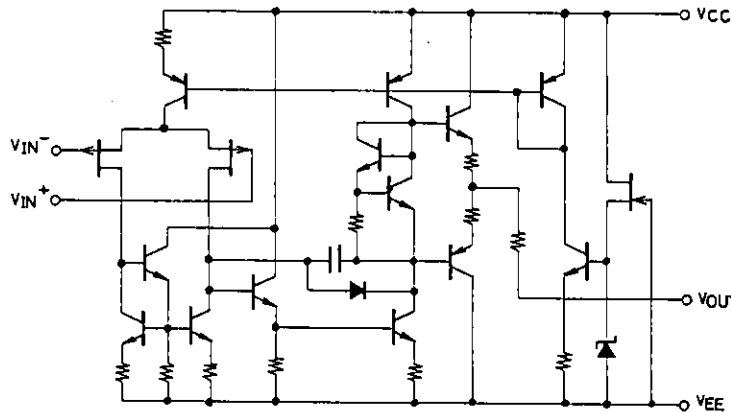

Pin Assignment

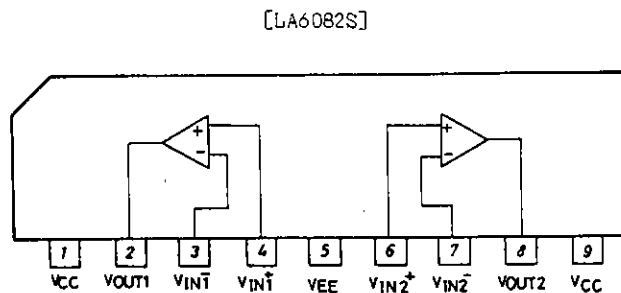
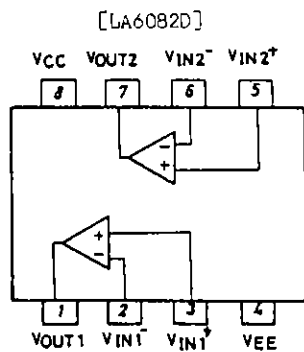

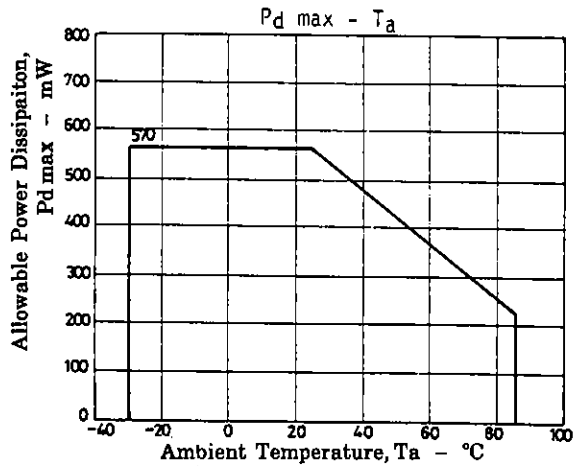
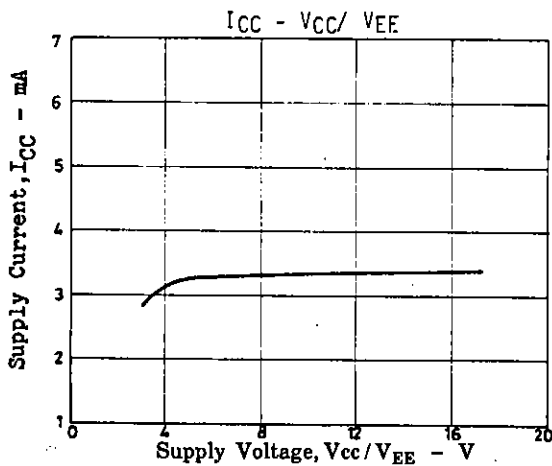
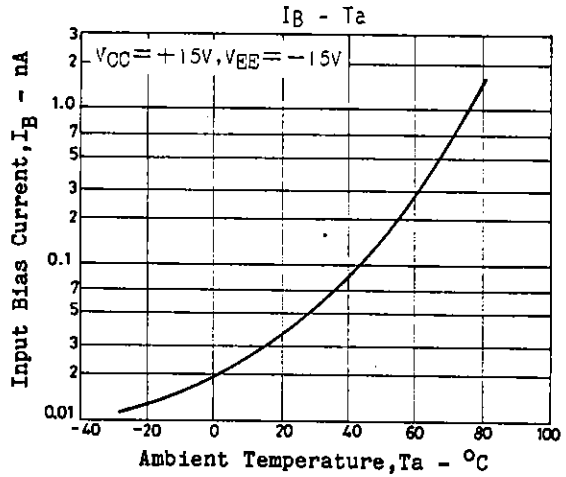
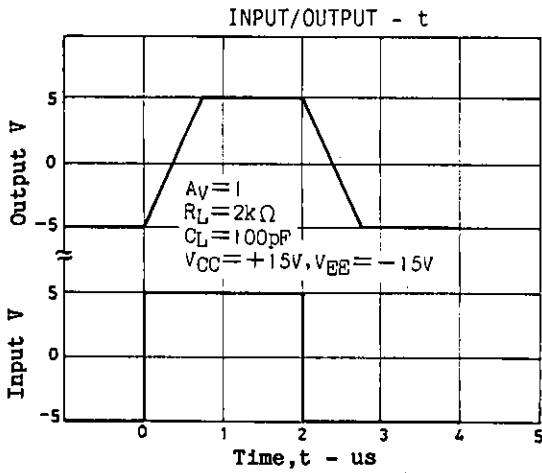
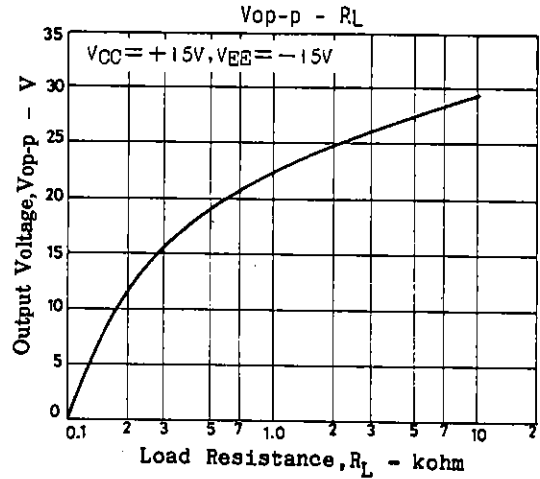
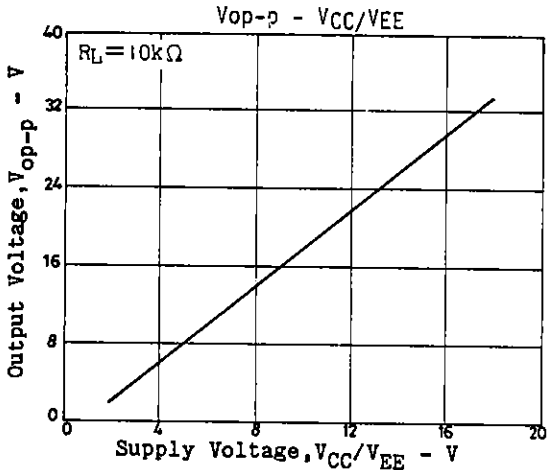
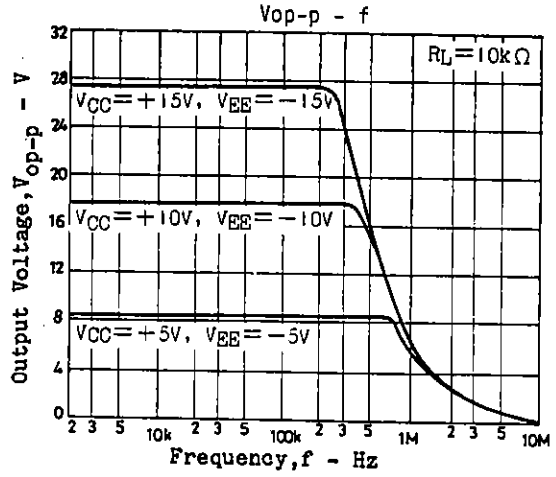
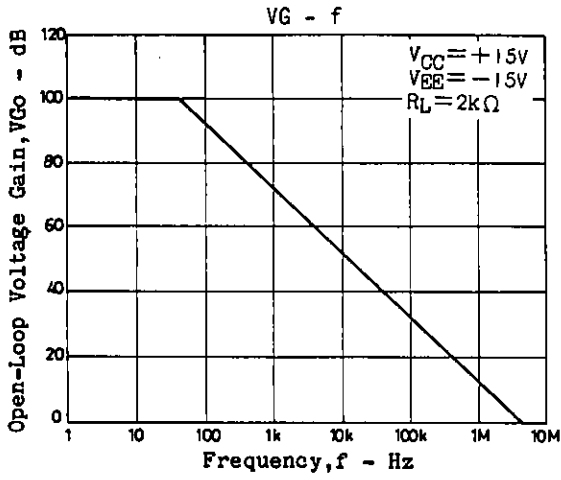

## Application Circuits

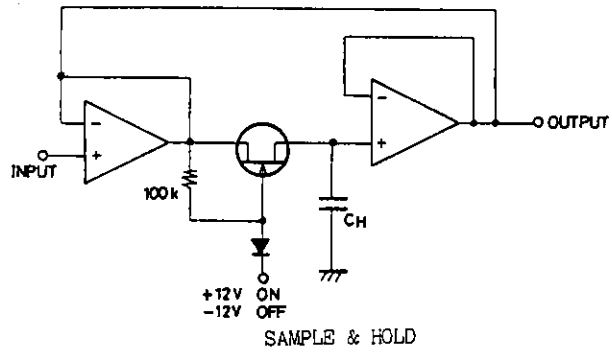
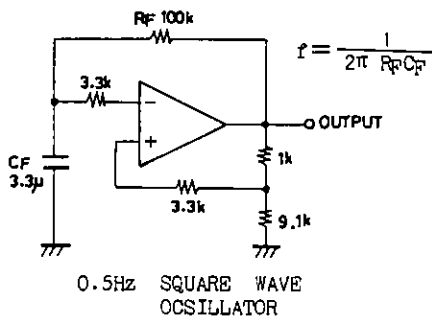
Unit (resistance:  $\Omega$ , capacitance: F)

- No products described or contained herein are intended for use in surgical implants, life-support systems, aerospace equipment, nuclear power control systems, vehicles, disaster/crime-prevention equipment and the like, the failure of which may directly or indirectly cause injury, death or property loss.
- Anyone purchasing any products described or contained herein for an above-mentioned use shall:
  - ① Accept full responsibility and indemnify and defend SANYO ELECTRIC CO., LTD., its affiliates, subsidiaries and distributors and all their officers and employees, jointly and severally, against any and all claims and litigation and all damages, cost and expenses associated with such use;
  - ② Not impose any responsibility for any fault or negligence which may be cited in any such claim or litigation on SANYO ELECTRIC CO., LTD., its affiliates, subsidiaries and distributors or any of their officers and employees jointly or severally.
- Information (including circuit diagrams and circuit parameters) herein is for example only; it is not guaranteed for volume production. SANYO believes information herein is accurate and reliable, but no guarantees are made or implied regarding its use or any infringements of intellectual property rights or other rights of third parties.