

No. 1820C

LA1265

FM/AM TUNER OF ELECTRONIC TUNING TYPE

Functions

- FM: IF amp, quadrature detector, AF preamp, signal meter, tuning indicator drive output (common with stop signal, muting drive output)
- AM: RF amp, MIX, OSC (with ALC), IF amp, detector, AGC, signal meter, tuning indicator drive output (common with stop signal).

Features

- . Minimum number of external parts required.
- . Excellent S/N
- . Local OSC with ALC
- . Local OSC buffer
- . Tuning indicator pin (common with narrow-band stop signal and muting drive output)
- . Variable stop sensitivity (variable separately for FM, AM)
- . Low whistle
- . Signal meter pin.

Maximum Ratings at Ta=25°C, See Test Circuit.

				unit
Maximum Supply Voltage	V _{CC} max	Pins 7, 8, 17	16	V
Flow-in Current	I ₈	Pin 8	20	mA
Flow-out Current	I ₂₀	Pin 20	1	mA
	I ₂₂	Pin 22	2	mA
Allowable Power Dissipation	P _d max	Ta=25°C	650	mW
Operating Temperature	T _{opr}		-20 to +70	°C
Storage Temperature	T _{stg}		-40 to +125	°C

Operating Conditions at Ta=25°C

				unit
Recommended Supply Voltage	V _{CC}		8.5	V
Operating Voltage Range	V _{CC} op		6 to 14	V

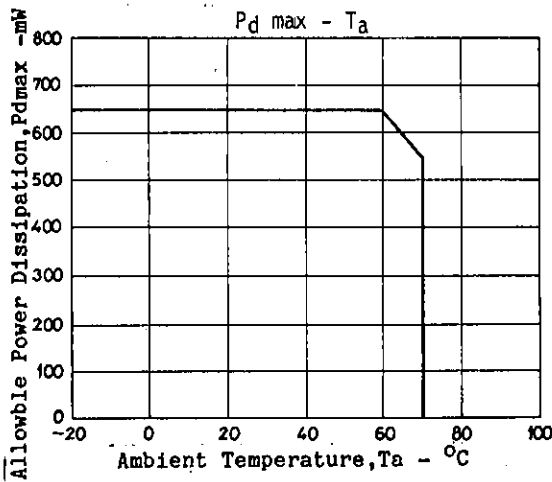

Package Dimensions 3059
(unit: mm)

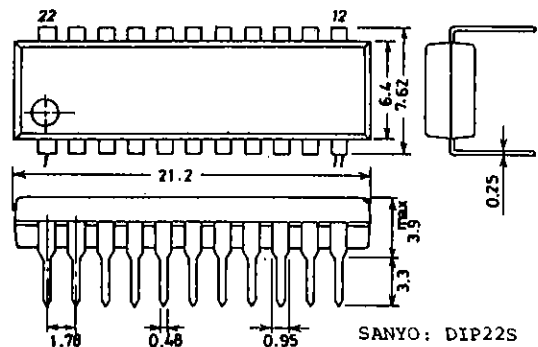

Operating Characteristics at Ta=25°C, V_{CC}=8.5V, See Test Circuit.

[AM: f=1MHz]

			min	typ	max	unit
Quiescent Current	I _{cco}	No input		18	26	mA
Detection Output	V _o (1)	V _i =20dBu, 400Hz, 30% mod.	30	50	90	mV
	V _o (2)	V _i =80dBu, 400Hz, 30% mod.	110	160	220	mV
S/N	S/N(1)	V _i =20dBu	16	20		dB
	S/N(2)	V _i =80dBu	49	54		dB
Total Harmonic Distortion	THD(1)	V _i =80dBu, 400Hz, 30% mod.		0.3	1.0	%
	THD(2)	V _i =107dBu, 400Hz, 30% mod.		0.5	2.0	%
Signal Meter Output	V _{SM} (1)	No input	0	0	0.2	V
	V _{SM} (2)	V _i =80dBu	2.4	2.8	3.1	V
LED Lighting Sensitivity	LED on	I _{LED} =1mA	15	24	33	dBu
Local OSC Buffer Output	V _{osc}	f _{osc} =1.45MHz	220	275	330	mV

[FM: f=10.7MHz]

			min	typ	max	unit
Quiescent Current	I _{cco}	No input		20	28	mA
Input Limiting Sensitivity	-3dBLS	3dBdown, 400Hz, 100% mod.		31	37	dBu
Demodulation Output	V _o	V _i =100dBu, 400Hz, 100% mod.	240	330	460	mV
S/N	S/N	V _i =100dBu	78	84		dB
Total Harmonic Distortion	THD	V _i =100dBu, 400Hz, 100% mod.		0.03	0.3	%
Signal Meter Output	V _{SM} (1)	No input	0	0	0.2	V
	V _{SM} (2)	V _i =100dBu	1.5	2.7	3.1	V
LED Lighting Sensitivity	LED-on	I _{LED} =1mA	35	50	65	dBu
LED Lighting Bandwidth	LED-BW	V _i =100dB, I _{LED} =1mA	90	120	160	kHz
AM Rejection	AMR	V _i =100dBu, FM=400Hz 100% mod. AM=1kHz 30% mod.	45	60		dB

Note: Be fully careful of dielectric breakdown.

Equivalent Circuit Block Diagram

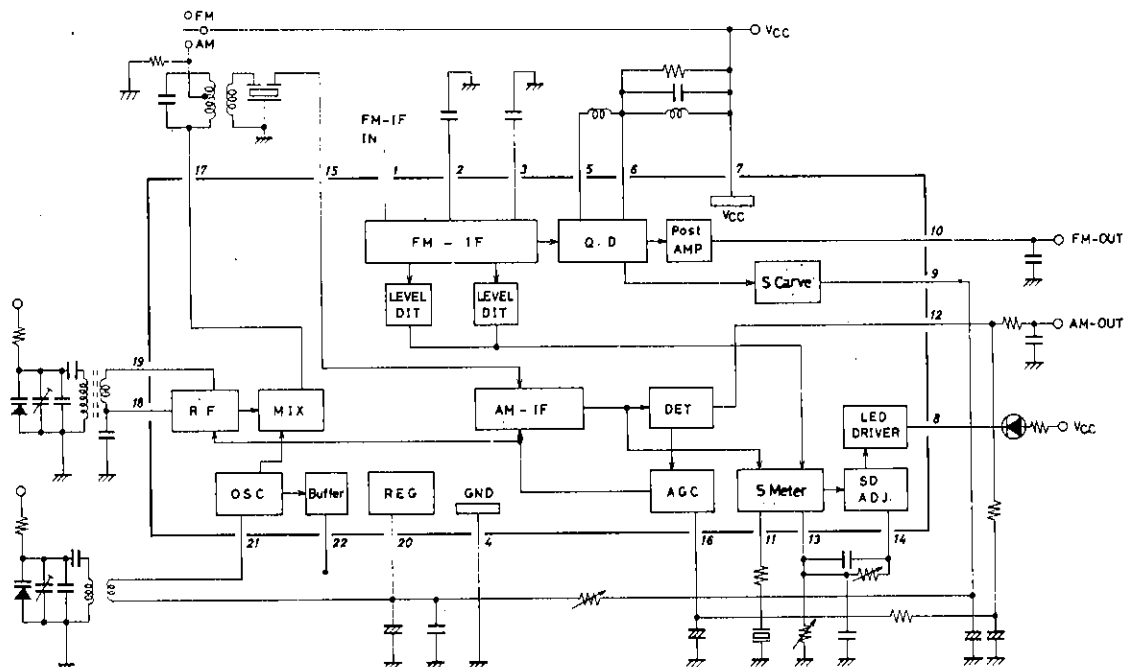

How to use the LA1265

1. LED lighting, muting drive output, stop signal (S.D)

- ① For LED lighting, muting drive output, stop signal, the output at pin 8 is used.
- ② The voltage on pin 8, when tuned, turns from "H" to "L". (Active-Low)
- ③ Signal bandwidth at pin 8
 - . For AM, the bandwidth depends on the CF (BFU450CN) at pin 11. If a capacitor is connected in place of the CF, the bandwidth will get wider.
 - . For FM, the bandwidth depends on the resistance across pins 9 and 20. If the resistance is increased, the bandwidth will get narrower. R=15kohms makes the bandwidth approximately 120kHz.

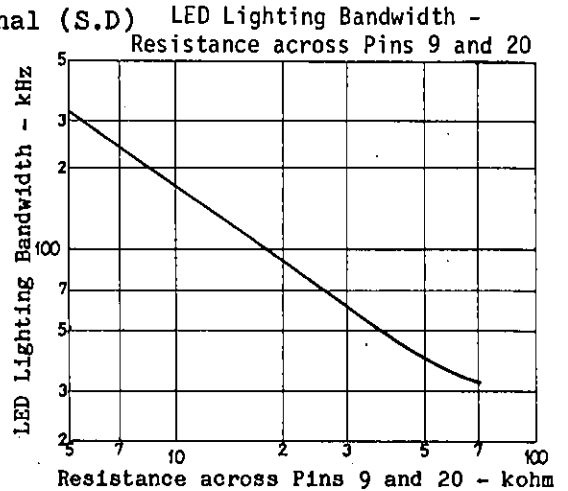

④ Sensitivity adjustment of LED, muting, stop signal

- . For FM, the semifixed variable resistor across pin 13 and GND is used.
 - . For AM, the semifixed variable resistor across pins 13 and 14 is used.
- Be sure to start adjustment for FM, and then make adjustment for AM. For the stop signal sensitivity and FM stop signal bandwidth, the variations should be considered and it is recommended to use the semifixed variable resistor for adjustment.

⑤ LED lighting sensitivity setting for AM

For the LED lighting sensitivity setting for AM, it is desirable that the IC input be 30dBu (antenna input: approximately 50dB/m). In this case, the value of VR1 is 30kohms.

⑥ LED lighting sensitivity setting for FM

For the LED lighting sensitivity setting for FM, the IC input may be 45dBu to 60dBu. With the variations in the front end considered, it is ideal that the IC input in a standard receiving set be 51dBu to 54dBu. The lower value of VR2 for the LED lighting sensitivity setting is as illustrated right. Since the variations in the front end cause the IC input setting sensitivity to vary, it is recommended to use a value of VR2 at an input voltage lower than a standard setting by 6dB or greater. For example, if IC input 53dBu is taken as a standard, use VR2=100kohms at IC input 47dBu.

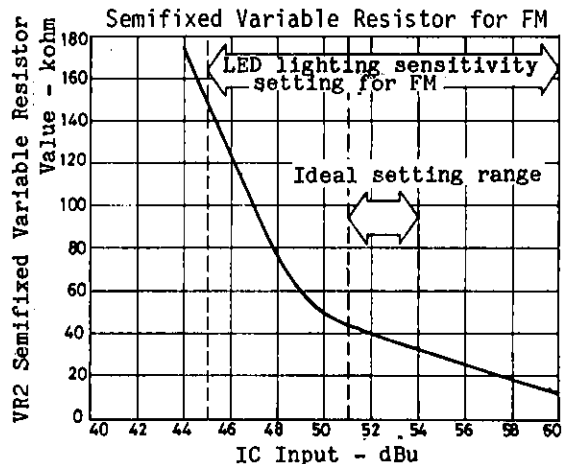

2. AM/FM changeover

- ① Two selections are available for changeover as shown below: (A) pin 17-used method and (B) pin 18-used method.
- ② For (A), the voltage on pin 17 relative to V_{CC} (pin 7) must be within the range of -0.8V to +0.1V. If not within this range, distortion and selectivity will get worse.
- ③ For (A), a resistance of 68kohms at the IFT cold terminal, which is used to prevent the changeover circuit from malfunctioning, must be connected.

(A) Pin 17-used method for AM/FM changeover

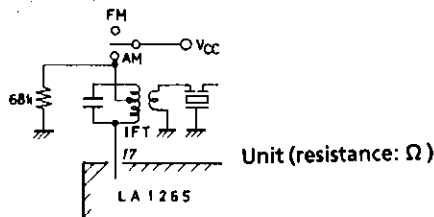

(B) Pin 18-used method for AM/FM changeover

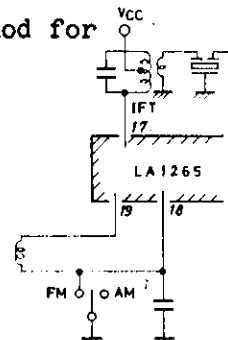

3. Local OSC buffer output

- ① When local OSC buffer output waveform is saw-toothed at the SW mode, connect a resistance of 1.2kohms or thereabouts across pin 22 and GND.

4. AM input pin

- ① It is desirable that the AM input pin (pin 19) be L-coupled to pin 18.
- ② Inputting to pin 19 can be done by DC-cutting with a capacitor. However, an unbalance in the RF amplifier (differential amplifier) causes gain drop and whistle worsening.

5. Capacitance across pin 9 and GND

A large capacitance across pin 9 and GND may cause a misstop at an adjacent channel when the channel select speed is made faster at the automatic channel select mode. In this case, decrease the capacitance across pin 9 and GND. However, if too decreased, the LED will flutter at low modulation frequencies at the time of detuning. Therefore, it is recommended to fix the capacitance across pin 9 and GND to be 3.3uF to 10uF. The relation between modulation frequency and demodulation output voltage on pin 9 with the capacitance across pin 9 and GND as a parameter is shown right.

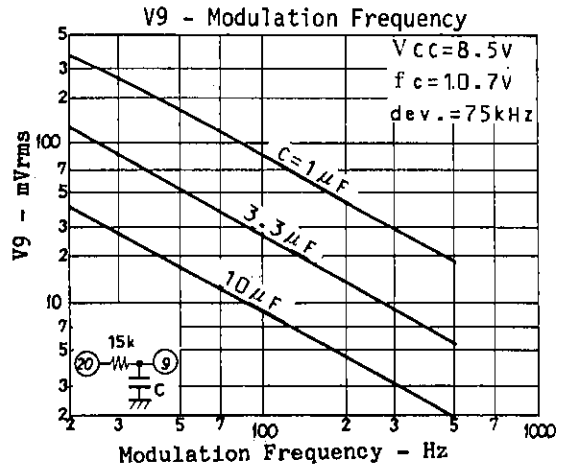

- 6. If the coupling coefficient of the local OSC coil is small and an anti-resonance point of approximately 100MHz is present or the stray capacitance across pins 22 and 21 is large, a parasitic oscillation of approximately 100MHz may occur in the buffer output (pin 22). In this case, connect a capacitance of approximately 30pF across pin 22 and GND.

7. AM OSC coil

Generally speaking, the following should be noted. Avoid winding with loose coupling between primary side and secondary side (especially SW1, SW2). To put it concretely, the pot core type is better than the screw core type which is loose in coupling. This prevents the local OSC frequency from turning third resonance frequency related to the coupling coefficient.

8. Resistance across pin 8 and V_{DD}

If pin 8 is used for the stop signal (SD) only, without using LED, it is recommended to fix resistance R_L across pin 8 and GND to be 51kohms to 100kohms.

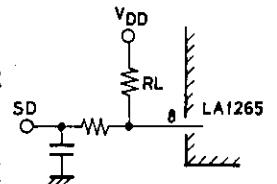

- 9. To prevent whistle from worsening, make the pattern of AM output pin 12 as short as possible.

Input/Output Admittance

FM

-	Parameter	Frequency	-	Admittance	unit
IF	y _{i11}	10.7MHz	r _i	330	Ω
			c _i	20	pF

AM

-	Parameter	Frequency	-	Admittance		unit
				AGC-off (V ₁₆ =1.4V)	AGC-on (V ₁₆ =2.5V)	
RF	y _{i19}	1MHz	r _i	15	16	kΩ
			c _i	4	4	pF
MIX	y _{o17}	500kHz	r _o	-	-	kΩ
			c _o	3	3	pF
IF	y _{i15}	500kHz	r _i	2	2	kΩ
			c _o	10	8	pF

Test Circuit : FM, AM-MW

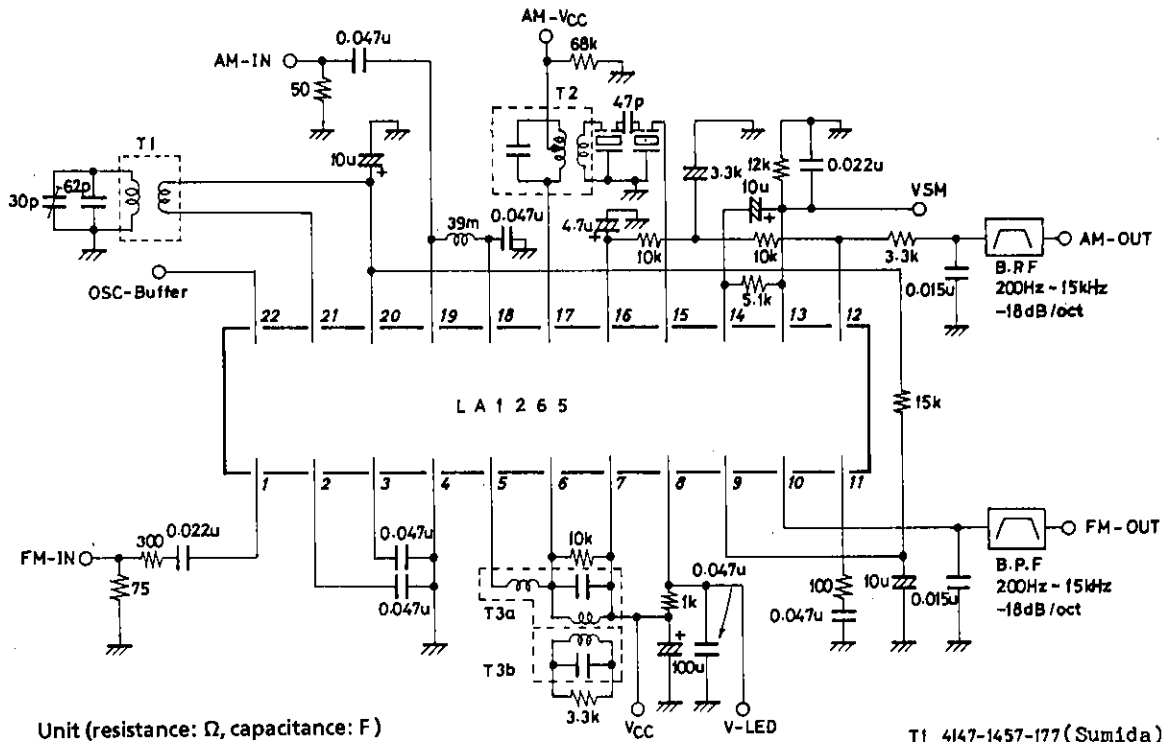

Unit (resistance: Ω , capacitance: F)

- T1 4147-1457-177 (Sumida)
- T2 HW-40174 (Mitsumi)
- T3a HW-40130, T3b HW-40131 (Mitsumi)

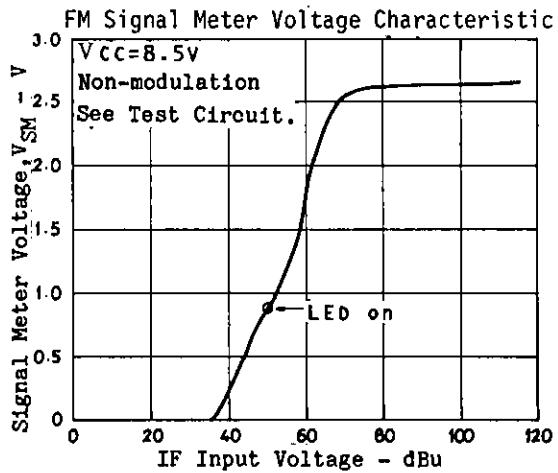
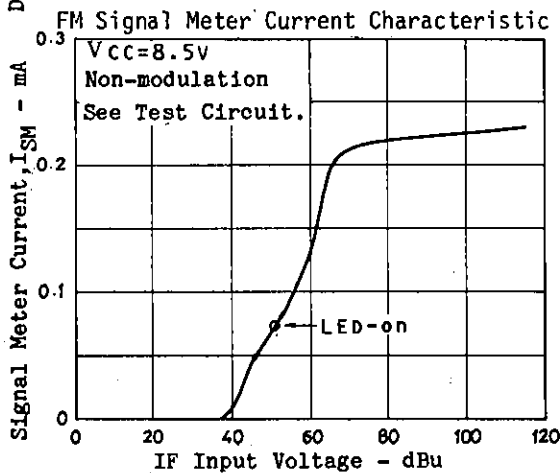
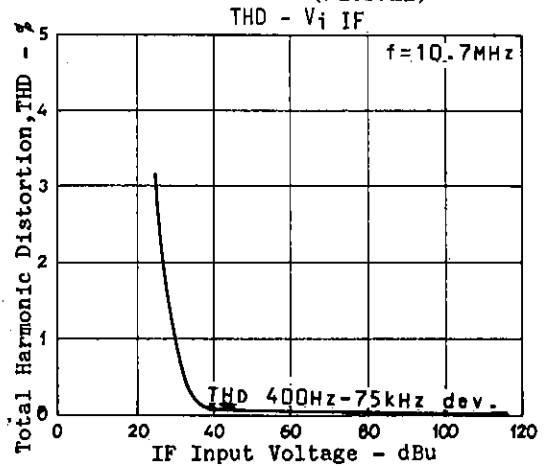
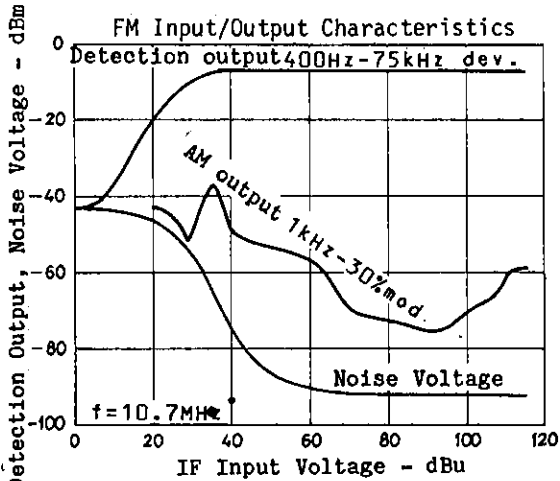

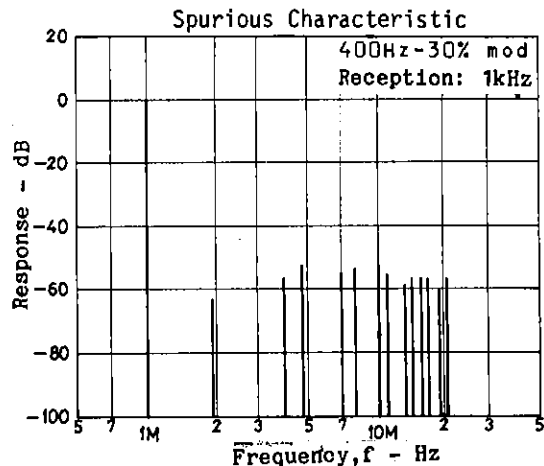
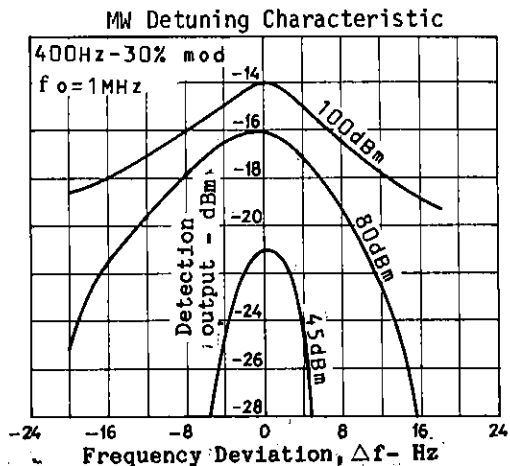
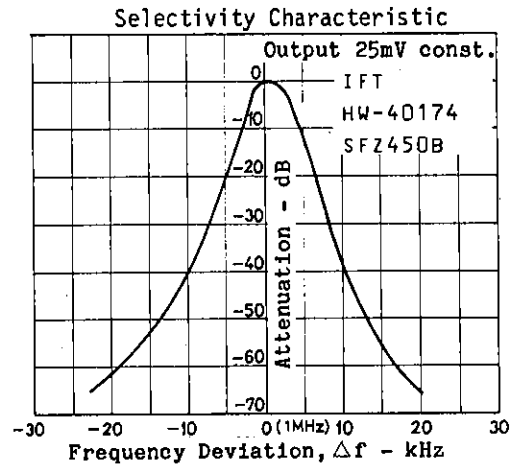
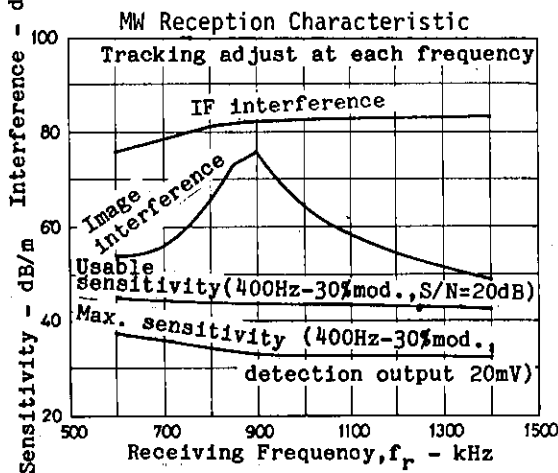
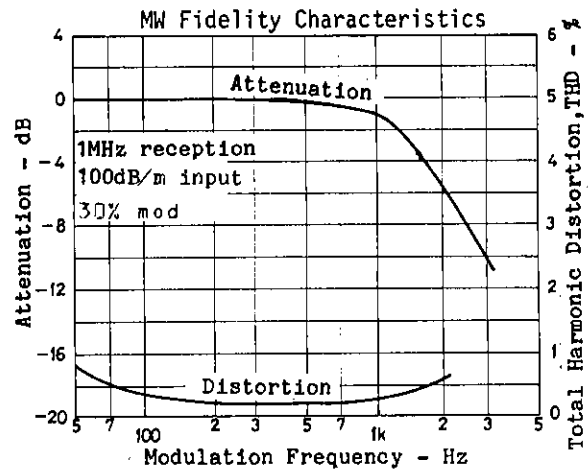
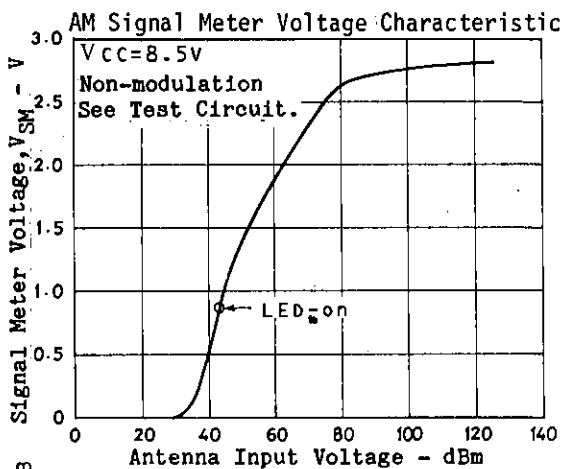
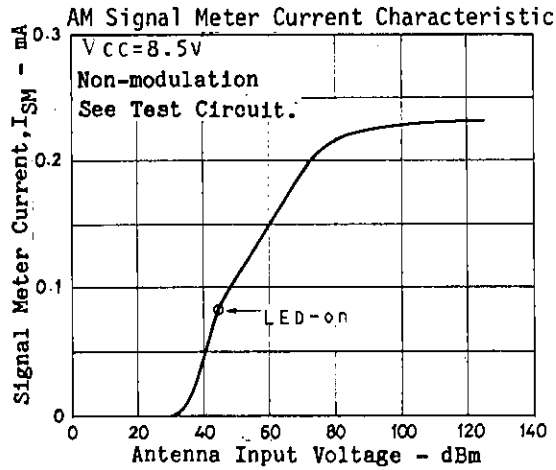
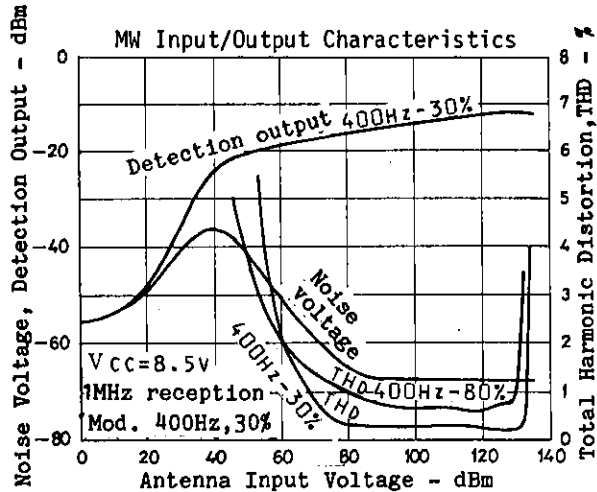

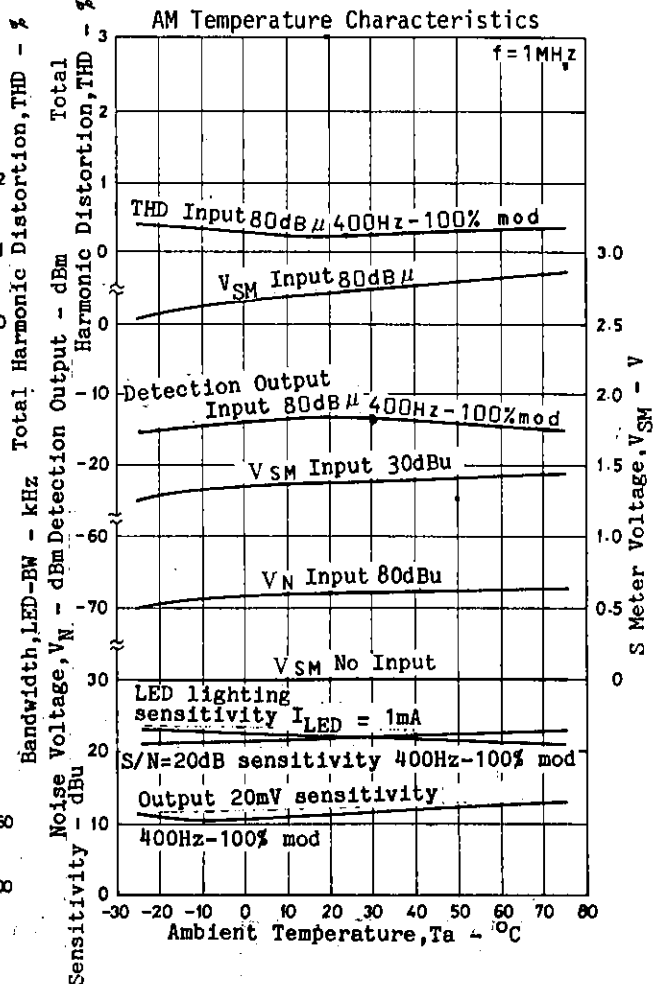
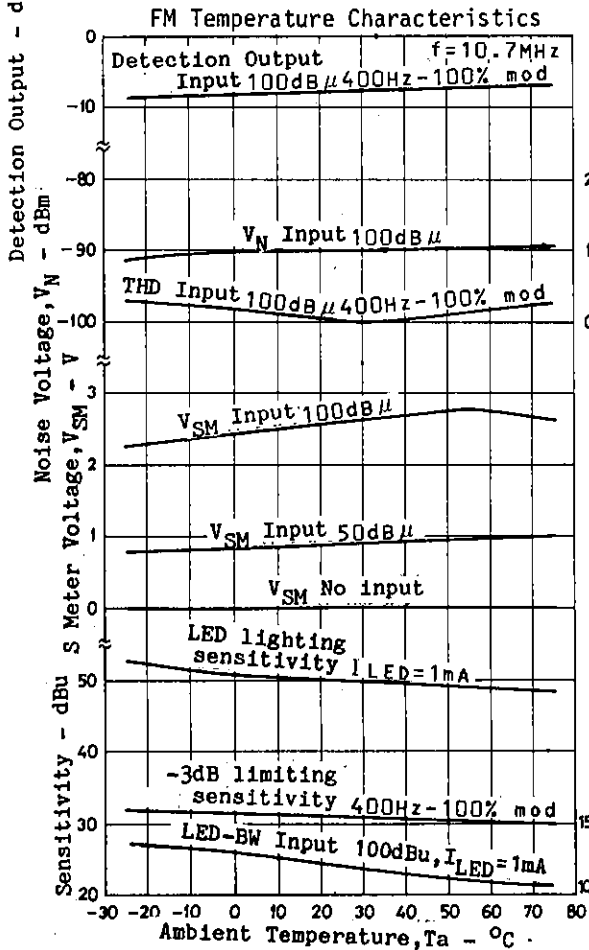
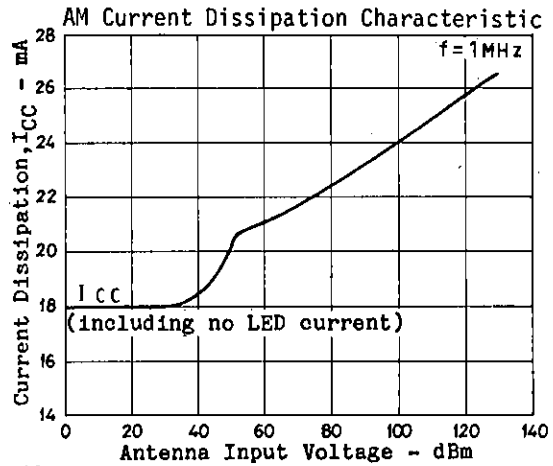
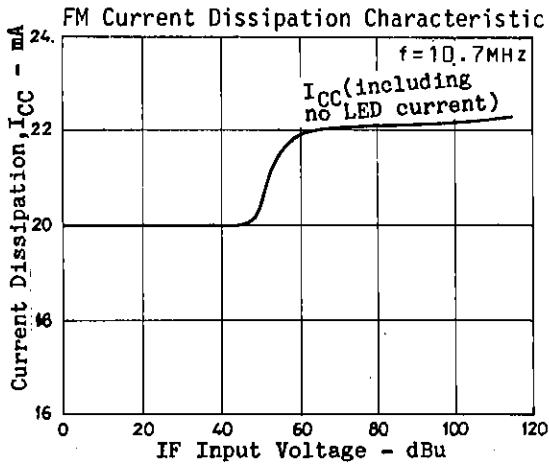
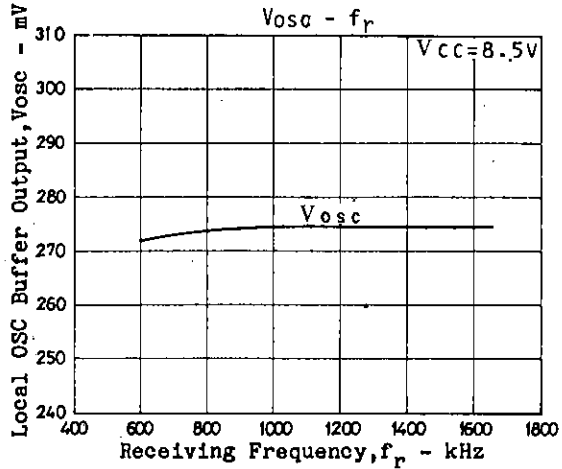
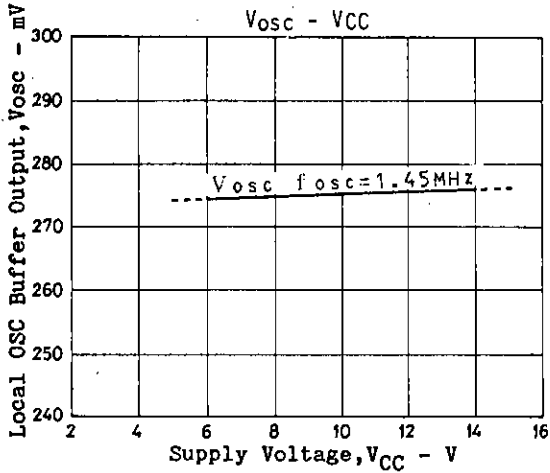

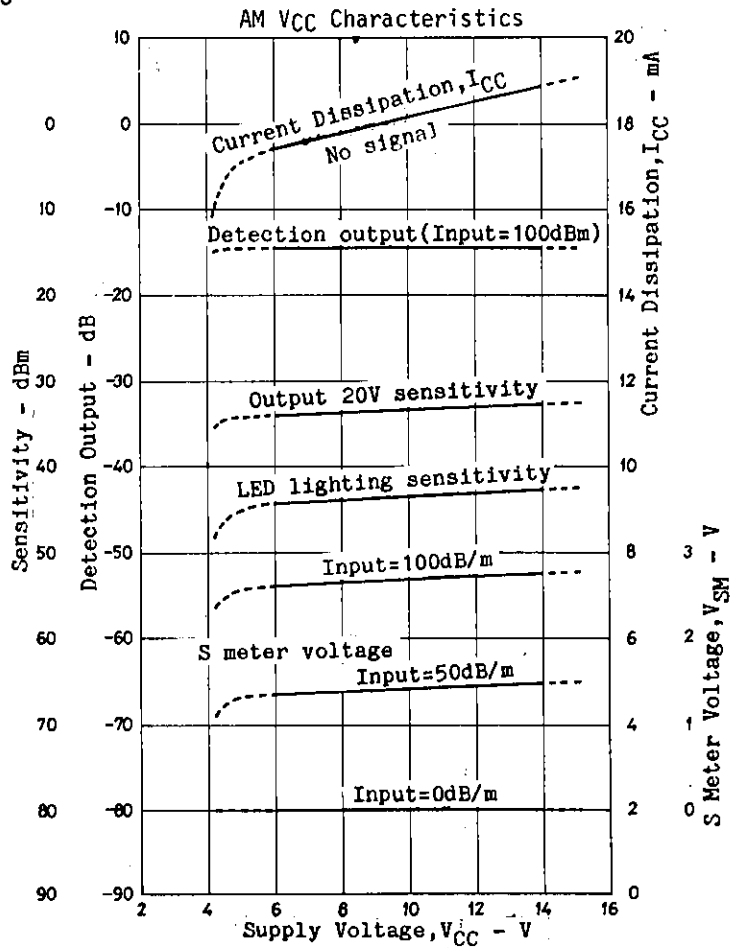
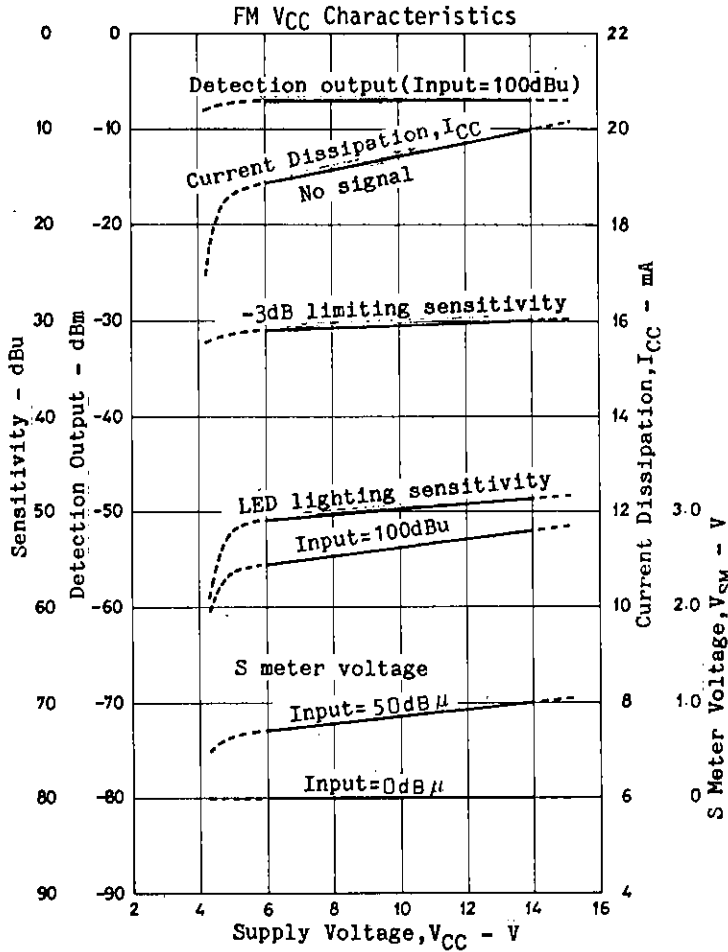

Test Circuit : SW2

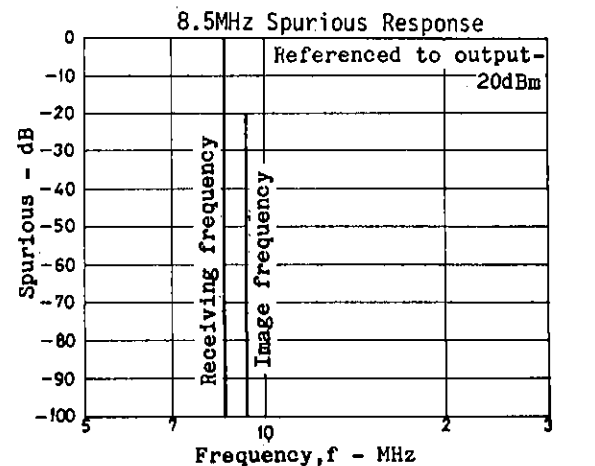
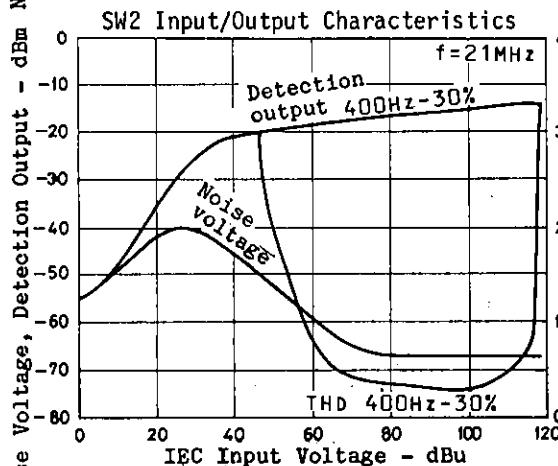
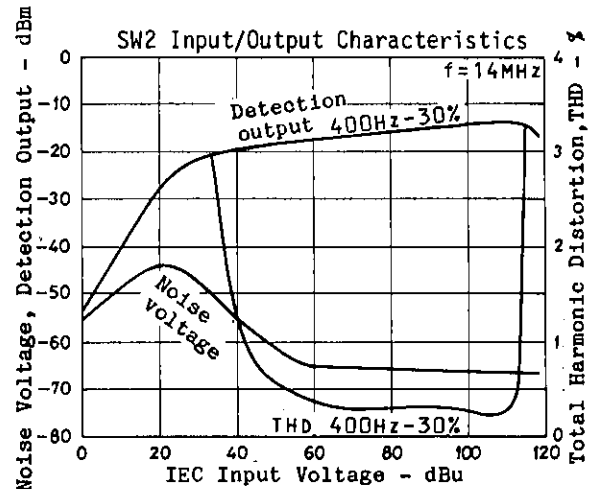
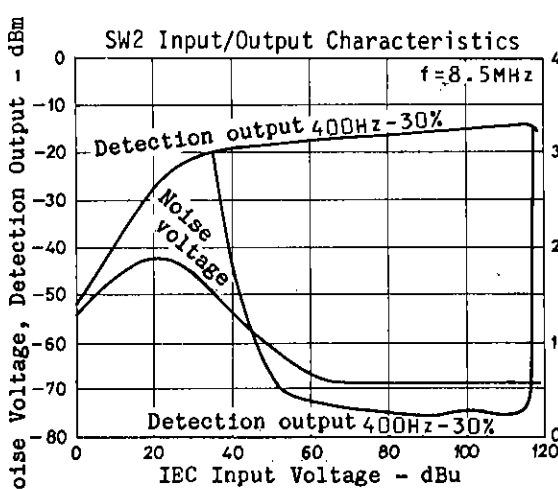
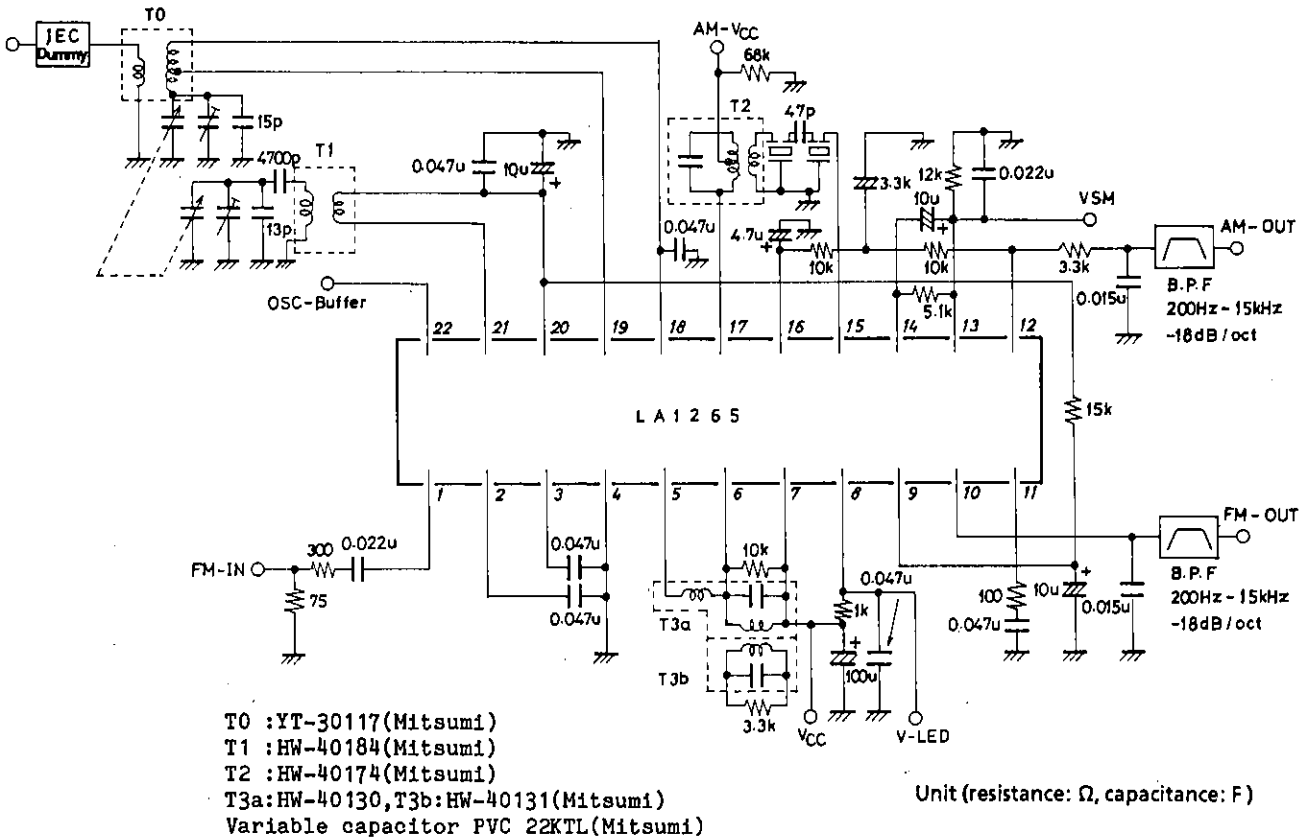

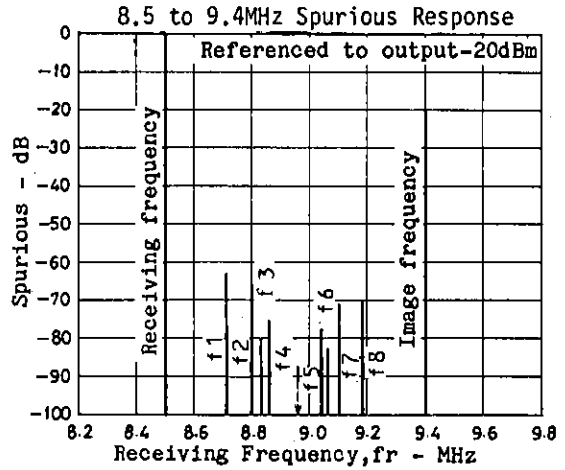
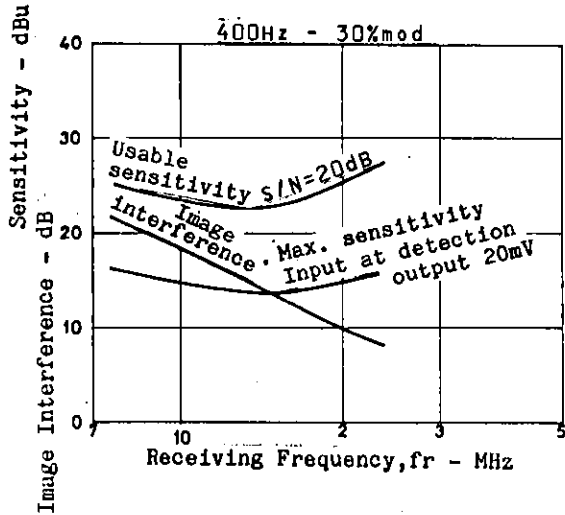

- f1: 8.724MHz → 2fosc-2f1=455kHz
- f2: 8.799MHz → 3fosc-3f2=455kHz
- f3: 8.836MHz → 4fosc-4f3=455kHz
- f4: 8.859MHz → 5fosc-5f4=455kHz
- f5: 9.038MHz → 5f5-5fosc=455kHz
- f6: 9.061MHz → 4f6-4fosc=455kHz
- f7: 9.098MHz → 3f7-3fosc=455kHz
- f8: 9.173MHz → 2f8-2fosc=455kHz

Coil Specifications

MW antenna

- Bar antenna (for PVC22KTL)
- IN-10896(Mitsumi)

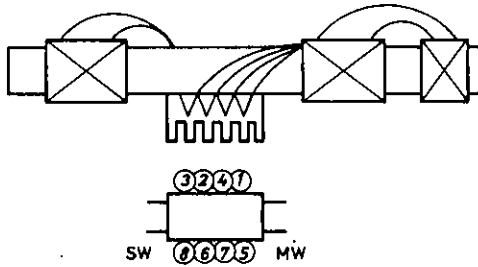

- ①-② 22T+49T, ③-④ 10T
- Tight solenoid direct winding
- ⑤-⑥ 17T 0.5φ space winding
- ⑦-⑧ 4T tight solenoid winding
- ①-② L=260μH, Qo=330(≥200)
- ⑤-⑥ L=15μH, Qo=250(≥150)

Loop antenna (for SVC321)

- LA300(Korin Giken)
- Loop antenna matching coil
- KL-412

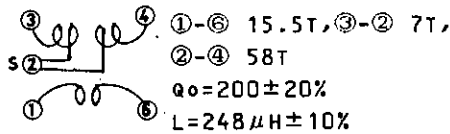

MW OSC

- 4147-1457-177(Sumida)
- For PVC22KTL

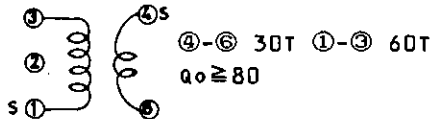

·K0-387(Korin Giken)

For SVC321

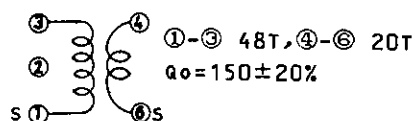

AM-IFT

Matching coil for SFU450B (1-element type)

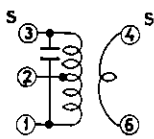

HW-40173 (Mitsumi)
 ①-② 82T, ③-④ 70T,
 ④-⑥ 7T
 $Q_0 = 110 \pm 20\%$, $f = 450\text{kHz}$
 Internal 180pF

2150-2162-197 (Sumida)
 ①-② 103T, ③-④ 71T,
 ④-⑥ 8T
 $Q_0 \geq 80$, $f = 450\text{kHz}$
 Internal 180pF

Matching coil for SFZ450B (2-element type)

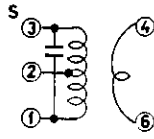

HW-40174 (Mitsumi)
 ①-② 58T, ③-④ 94T,
 ④-⑥ 10T
 $Q_0 = 80 \pm 20\%$, $f = 450\text{kHz}$
 Internal 180pF

2150-2061-049 (Sumida)
 ①-② 54T, ③-④ 120T,
 ④-⑥ 12T
 $Q_0 \geq 40$
 Internal 180pF

FM single tuning detection coil

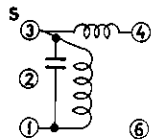

HW-40122 (Mitsumi)
 ③-④ 84.5T, ③-① 19T
 $Q_0 = 35 \pm 20\%$, $f = 10.7\text{MHz}$
 Internal $82\text{pF} \pm 10\%$
 Damping resistance

2231-016 (Sumida)
 ③-④ 73.5T, ③-① 19T
 $Q_0 = 30 \pm 20\%$, $f = 10.7\text{MHz}$
 Internal $82\text{pF} \pm 10\%$
 Damping resistance

FM double tuning detection coil

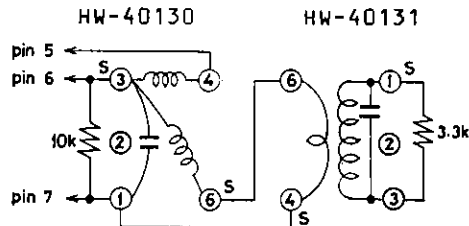

HW-40130 (Mitsumi)	HW-40131 (Mitsumi)
③-④ 86.5T	④-⑥ 1T
③-⑥ 13.5T	①-③ 19T
$Q_0 = 50 \pm 20\%$	$Q_0 = 35 \pm 20\%$
Internal $100\text{pF} \pm 10\%$	Internal $100\text{pF} \pm 10\%$

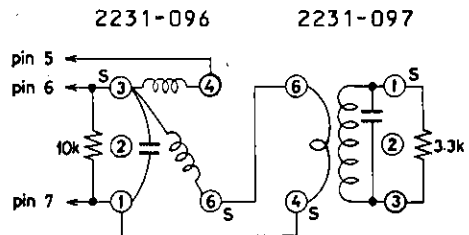

2231-096 (Sumida)	2231-097 (Sumida)
③-④ 73.5T	④-⑥ 2T
③-⑥ 23.5T	①-③ 21T
$Q_0 = 50 \pm 20\%$	$Q_0 = 47 \pm 20\%$
Internal $62\text{pF} \pm 10\%$	Internal $82\text{pF} \pm 10\%$

Unit (resistance: Ω)

Sample Application Circuit: LA1186N + LA1265(US Band)

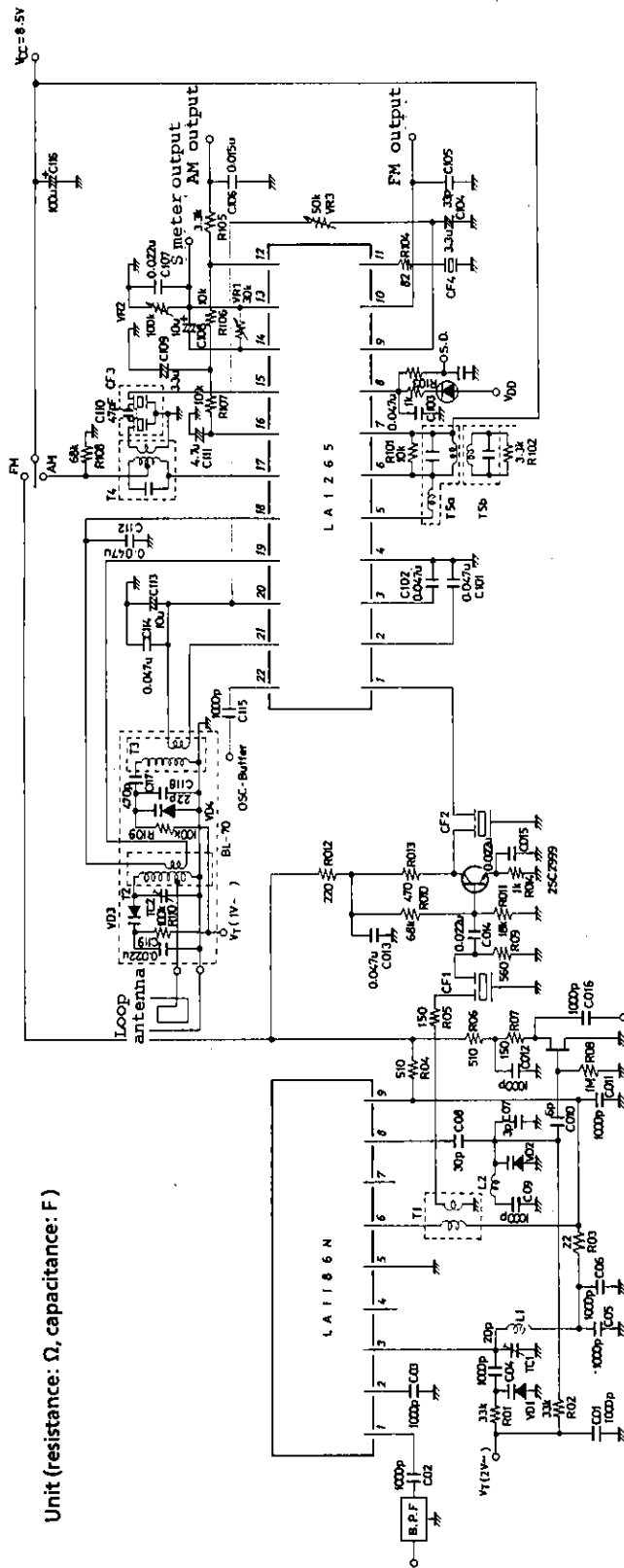

Unit (resistance: Ω, capacitance: F)

- T1 : YT-30224 (Mitsumi)
- T2 : KL412 (Korin) BL-70
- T3 : KO387 (Korin)
- T4 : HW-40174 (Mitsumi), 2150-2061-049 (Sumida)
- T5a : HW-40130 (Mitsumi), 2231-096 (Sumida)
- T5b : HW-49131 (Mitsumi), 2231-097 (Sumida)

- B.P.F SNY-2101 (Sumida)
- VD1, VD2 = SVC201
- VD3, VD4 = SVC321
- TC1 = 20PF
- TC2 = 20PF
- CF1, CF2 = SFE10.7MA
- CF3 = SFZ450B (Murata)
- CF4 = BFFU450CN (Murata)
- L1: YT-30196 (Mitsumi), 0708-700 (Sumida)
- L2: HW50433 (Mitsumi), 0267-034 (Sumida)

LA1265

Example of Printed Pattern (Cu-foiled area)

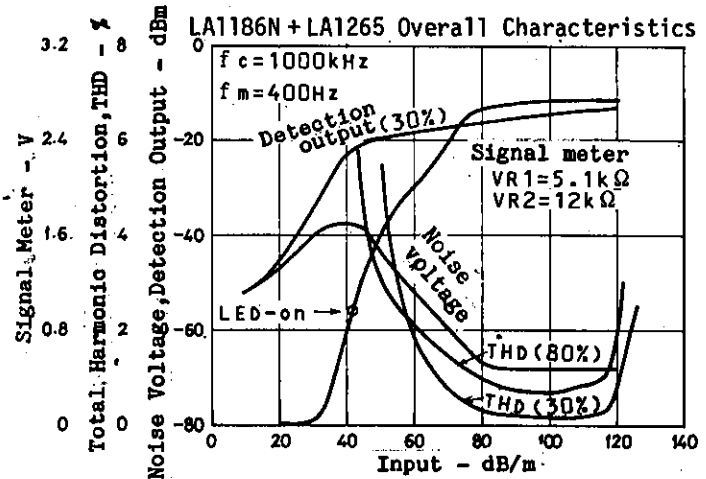
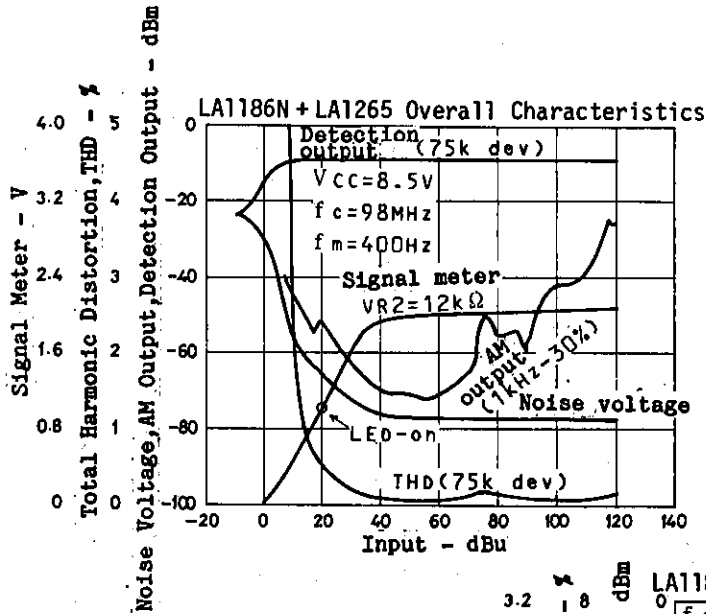
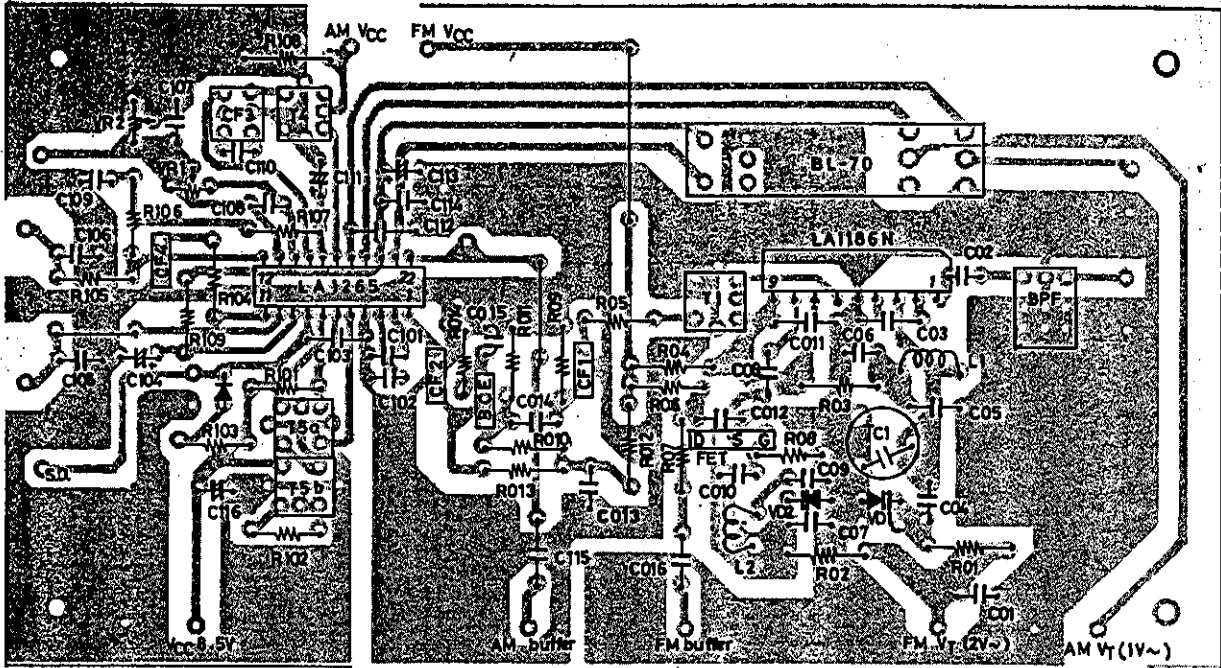

- No products described or contained herein are intended for use in surgical implants, life-support systems, aerospace equipment, nuclear power control systems, vehicles, disaster/crime-prevention equipment and the like, the failure of which may directly or indirectly cause injury, death or property loss.
- Anyone purchasing any products described or contained herein for an above-mentioned use shall:
 - ① Accept full responsibility and indemnify and defend SANYO ELECTRIC CO., LTD., its affiliates, subsidiaries and distributors and all their officers and employees, jointly and severally, against any and all claims and litigation and all damages, cost and expenses associated with such use:
 - ② Not impose any responsibility for any fault or negligence which may be cited in any such claim or litigation on SANYO ELECTRIC CO., LTD., its affiliates, subsidiaries and distributors or any of their officers and employees jointly or severally.
- Information (including circuit diagrams and circuit parameters) herein is for example only; it is not guaranteed for volume production. SANYO believes information herein is accurate and reliable, but no guarantees are made or implied regarding its use or any infringements of intellectual property rights or other rights of third parties.